

e-book

An Introduction to Photography

A comprehensive guide to the online course



**MUHAMAD SHUKRI BIN ISMAIL
MOHD RAZIF BIN MUSTAPHA
SYAIFUL EIZLAN BIN MAHMOOD**

An Introduction to the Six Essentials of Photography

Light • Subject • Optics • Aperture • Time • Recording Medium

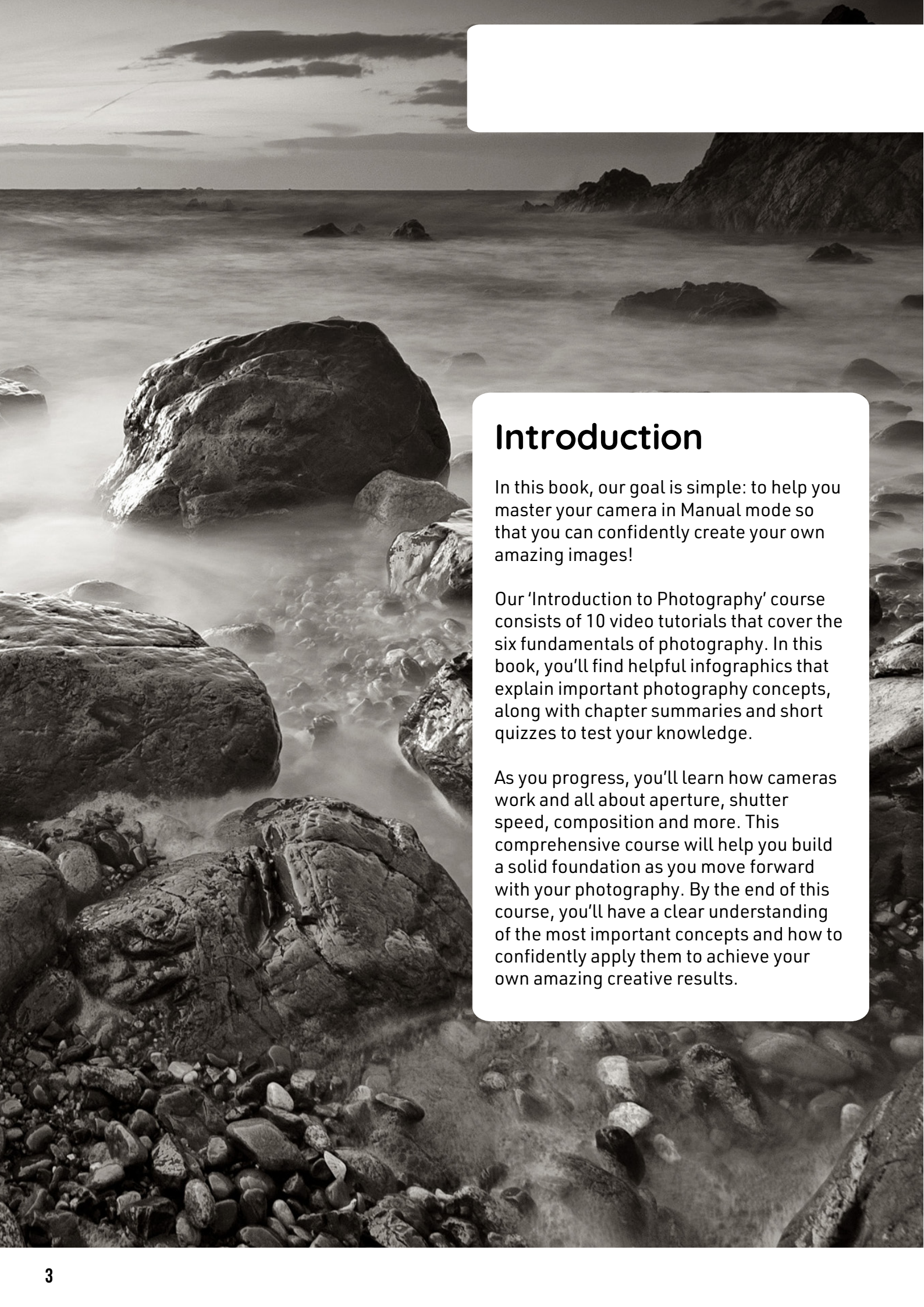

Introduction

In this book, our goal is simple: to help you master your camera in Manual mode so that you can confidently create your own amazing images!

Our 'Introduction to Photography' course consists of 10 video tutorials that cover the six fundamentals of photography. In this book, you'll find helpful infographics that explain important photography concepts, along with chapter summaries and short quizzes to test your knowledge.

As you progress, you'll learn how cameras work and all about aperture, shutter speed, composition and more. This comprehensive course will help you build a solid foundation as you move forward with your photography. By the end of this course, you'll have a clear understanding of the most important concepts and how to confidently apply them to achieve your own amazing creative results.

CONTENTS

- 1 How Does Your Camera Work?** p. **5**
- 2 What Is Exposure in Photography?** p. **10**
- 3 Shutter Speed** p. **21**
- 4 Camera Focus** p. **29**
- 5 Aperture and Depth of Field** p. **35**
- 6 Get Creative in Manual Mode** p. **42**
- 7 Optics and Lenses** p. **50**
- 8 Understanding Light** p. **59**
- 9 The Recording Medium** p. **68**
- 10 Composition** p. **78**
- 11 Printable Infographics** p. **86**



CHAPTER 1

HOW DOES YOUR CAMERA WORK?

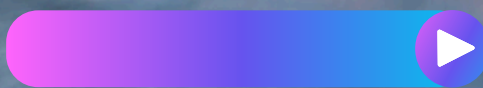

An Introduction to the Six Essentials of Photography
Light • Subject • Optics • Aperture • Time • Recording Medium

HOW DO CAMERAS WORK?

THE SIX ESSENTIALS

Photographic technology never stops advancing. Cameras have shrunk to fit in our pockets, film has largely been replaced by digital, and mirrorless is quickly growing in popularity. But despite these changes, cameras (no matter the cost, brand or format) still all work in roughly the same way. Photography can be broken into six essentials: light, subject, optics, aperture, time and the recording medium. In this course, this course you'll see how these relate to the photographic process and how we create images.

To start, we need light to record an image. This light reflects off the subject before entering the optics (or lens) and passing through the aperture. This light then hits a mirror, which bounces the light up into a prism and out through the viewfinder. Mirrorless cameras have done away with mirrors and instead have an electronic viewfinder (EVF) that creates a preview of the image. No matter which camera you're using, the light then has to be recorded for a certain amount of time (controlled by the shutter) before it is recorded by the medium. By pressing the shutter button, light passes through the shutter to be recorded by the medium.

HOW CAMERAS WORK THE 6 ESSENTIALS

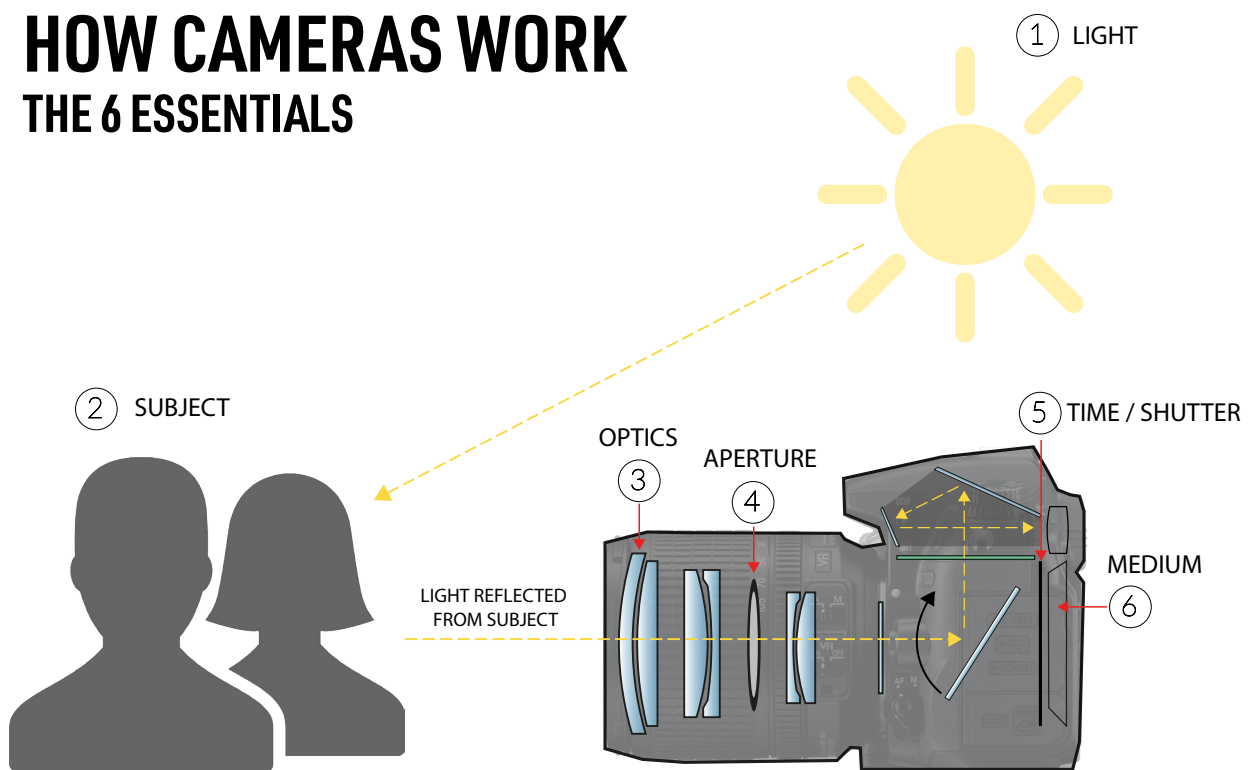

1. LIGHT

Light is essential to any image, and can be used to evoke different moods, atmospheres or feelings. As photographers, our job is to control and use light to create the best possible image.



2. SUBJECT

The subject is simply what we photograph. It can be anything. How we compose and light an image of our subject effects how a viewer will respond to it.



3. CAMERA OPTICS

Optics, or lenses, are what focus the available light so that it can be recorded by the medium. Different lenses have their own characteristics that control the focal length, the angle of view and magnification of an image.



4. APERTURE

The aperture is a hole in the lens through which light passes before reaching the recording medium. Denoted by the letter 'f', it controls how much light is recorded in an image, as well as the depth of field (how much of the image is sharp).



5. TIME

Shutter speed refers to how long the shutter remains open. It is recorded in seconds, tenths or hundredths of a second (e.g. 1", 1/10 or 1/2000). The slower the shutter speed, the more light is recorded.



6. RECORDING MEDIUM

Once light passes through the lens, aperture and shutter, it reaches a digital sensor that records the image. Modern cameras predominantly feature sensors that are either full-frame, crop or medium format.

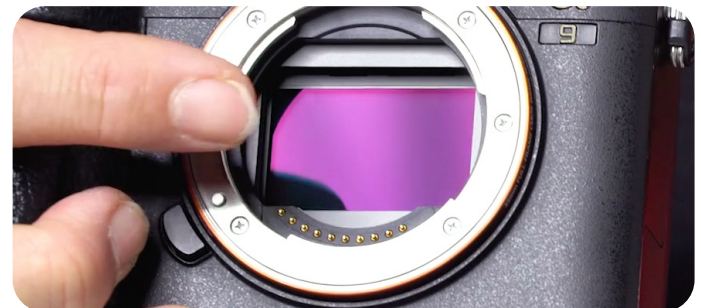

1. HOW DO CAMERAS WORK?

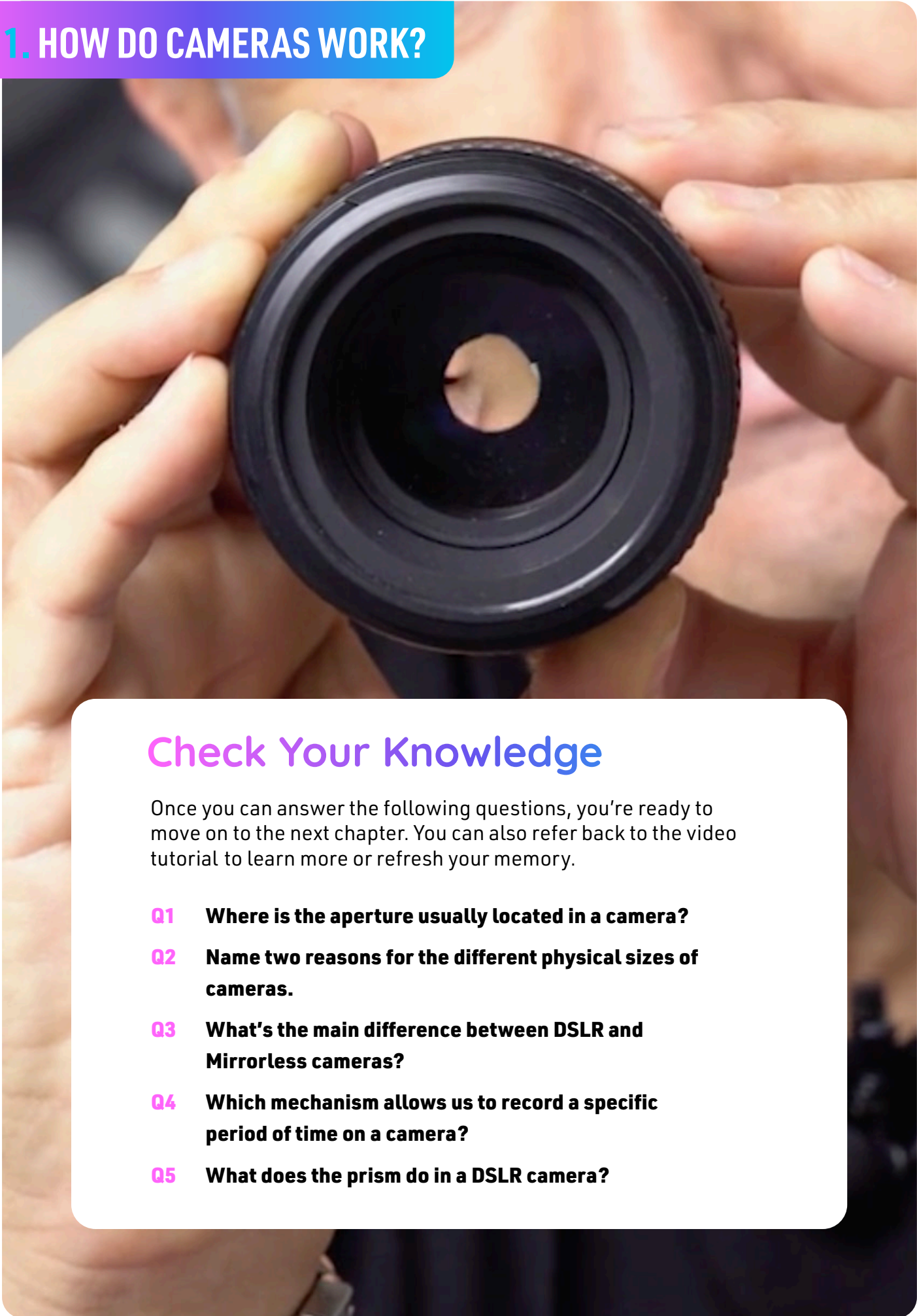

Check Your Knowledge

Once you can answer the following questions, you're ready to move on to the next chapter. You can also refer back to the video tutorial to learn more or refresh your memory.

- Q1** Where is the aperture usually located in a camera?
- Q2** Name two reasons for the different physical sizes of cameras.
- Q3** What's the main difference between DSLR and Mirrorless cameras?
- Q4** Which mechanism allows us to record a specific period of time on a camera?
- Q5** What does the prism do in a DSLR camera?



“

**THE SAME
FUNDAMENTAL
PRINCIPLES OF
PHOTOGRAPHY ARE
APPLICABLE ACROSS
ALL CAMERA TYPES
AND IT IS THESE
FUNDAMENTALS THAT
WE'LL BE EXPLORING IN
THIS COURSE. ”**





CHAPTER 2

WHAT IS EXPOSURE IN PHOTOGRAPHY?



An Introduction to the Six Essentials of Photography
Light • Subject • Optics • Aperture • Time • Recording Medium

WHAT IS EXPOSURE IN PHOTOGRAPHY?



SHUTTER SPEED AND EXPOSURE

Exposure refers to the brightness of an image. One way to control it is to adjust the shutter speed.

The shutter speed (referred to as 'Time' in the six essentials) is how long the shutter remains open when recording an image. The slower the shutter speed, the longer the shutter remains open, the more light recorded by the recording medium, the brighter the image. The faster the shutter speed, the less time the shutter stays open, the less light will be recorded, the darker the image. For example, a shutter speed

of 1" (one second) will record more light than a faster shutter speed of 1/500 (one five-hundredth of a second). To achieve the correct exposure, it's necessary to select an appropriate shutter speed based on the lighting conditions and the creative effect you want. When you're working in low light conditions, it's often necessary to use slower shutter speeds to get the best exposure. When you're photographing on a bright, sunny day, the opposite is true. In this case, it might be necessary to use a faster shutter speed to cut out some of the bright light to get the correct exposure.

SHUTTER SPEED

TIME



1" 1/2 sec 1/4 sec 1/8 sec 1/15 sec 1/30 sec 1/60 sec 1/125 sec 1/250 sec 1/500 sec 1/1000 sec

SLOW SHUTTER SPEED

FAST SHUTTER SPEED

LIGHT

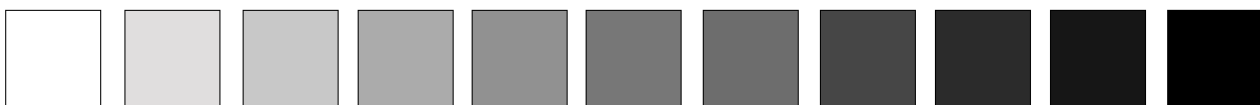

MORE LIGHT

LESS LIGHT

APERTURE AND EXPOSURE

Another way to control exposure is by adjusting the aperture, which is the opening in the lens that light passes through before reaching the recording medium. A larger hole will allow more light to pass through, while a smaller hole will allow less light to pass through. When you're shooting in low light conditions, larger apertures (like f1.4) can be a good choice as they allow more light to reach the sensor. In bright conditions, when it may be necessary to limit the amount of light reaching the sensor, smaller apertures can be used. A key thing to remember with apertures is that smaller f-stop numbers (like f2.8) refer to larger

apertures, or larger openings in the lens. On a given lens, f1.8 may be the largest aperture, allowing the most light to enter the lens, while f32 may be the smallest aperture, allowing the least amount of light to enter the lens. We can control exposure by using the aperture or shutter speed individually, or by using the shutter speed and aperture together.

CONTROLLING EXPOSURE

Exposure is a key part of photography, and knowing how to correctly expose an image is essential. This fundamental skill is something photographers often struggle with, especially if they don't fully understand the concept of exposure or how to control it. Measured in stops, exposure refers to the brightness or darkness of an image and is controlled by adjusting the shutter speed and/or aperture. We can increase or decrease the brightness level by adjusting the shutter speed, the aperture or a combination of both. Determining the correct exposure depends on what creative effect you'd like to achieve. For example, do you want a shallow or large depth of field, motion blur or no motion blur? Once you've decided this, it is necessary to find a balance between the shutter speed and aperture to get the correct exposure. Your camera's built-in light meter will give a good indication of your current exposure and you can use this to adjust your settings as necessary. If an image is too dark, you can either decrease the shutter speed or open the aperture. If an image is too bright, you can either increase the shutter speed or close the aperture.

ONE-STOP CHANGES

When it comes to controlling exposure, an important concept to understand is that of one-stop changes. Once you understand one-stop changes, you'll better understand how changes in light work in photography. Any change in shutter speed or aperture that doubles or halves the amount of light is known as a one-stop change in exposure. For example, a change from f32 to f22 is a one-stop increase, the same way 1/60 to 1/125 is a one-stop decrease. Aperture is measured in f-stops and most modern lenses follow the same f-stop scale: f1, f1.4, f2, f2.8, f4, f5.6, f8, f11, f16, f22, f32. Shutter speed is also measured in stops, with most cameras typically featuring speeds between 1/8000 and 30". A typical shutter speed scale may look like this: 1", 1/2, 1/4, 1/8, 1/15, 1/30, 1/60, 1/125, 1/250, 1/500, 1/1000 etc. Exposure can also be measured in one-third stop changes (shown in the image opposite). Although this allows for more precise control when exposing an image, we recommend that you use full one-stop changes to start with.

UNDERSTANDING ONE-STOP CHANGES

Below is a visual representation of one-stop and one-third stop exposure changes for both aperture and shutter speeds.

EXPOSURE CHANGES

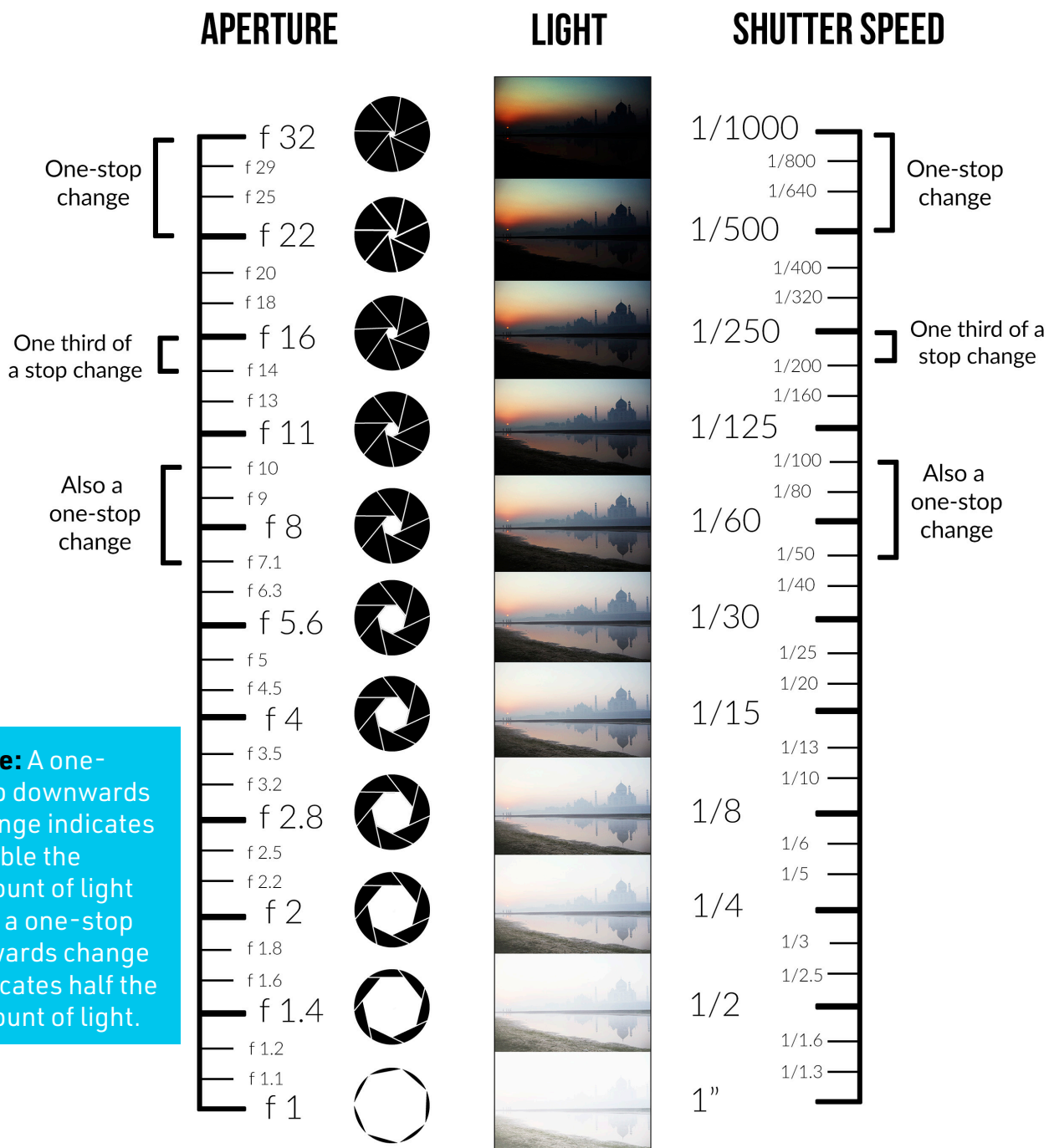

Note: A one-stop downwards change indicates double the amount of light and a one-stop upwards change indicates half the amount of light.

A CAMERA'S VIEW FINDER

So you've just unpacked your camera and are ready to take your first picture. But looking through the viewfinder, you're not sure what everything means! Don't panic – we've created a simple guide to explain it all. To start, let's explain what a viewfinder is. The viewfinder is what allows us to view and compose our image and it tells us what settings will be used to record the image.

These include the exposure, shutter speed, aperture and ISO. The viewfinder also allows us to see where the focus point is, what mode we're shooting in and even the battery level. Opposite are two examples of a typical viewfinder, labelled with what each part means. To start with, the most important things you should be able to identify are the exposure scale (or light meter), shutter speed and aperture. Remember, although displays might vary between camera brands, the fundamentals remain the same.

VIEWFINDER KEY:

Shutter Speed

Looking through the viewfinder, you'll see a combination of symbols and numbers. The first set of numbers you see indicates the shutter speed. A shutter speed of 1/100 will show in the viewfinder as 100, 1/50 as 50, 1/2 as 2, and so on. In addition, a one-second exposure will be shown as 1", two-seconds as 2" and so on.

Aperture

The aperture is the second set of numbers seen in the viewfinder. These numbers can vary from as low as 1 (a large aperture) to 32 (a small aperture). Larger apertures let in more light, while smaller apertures let in less light. How low this number can go depends on the lens you're using.

Exposure Scale

Also referred to as a light meter, this estimates the exposure of the image. A centred marker indicates a well exposed image. Anything to the left indicates an underexposed image. Anything to the right indicates an overexposed image.

Manual Mode

If you see the letter M, you are using your camera in Manual mode. This letter changes depending on which mode you're shooting in. For example, A may indicate Auto mode, TV may indicate shutter priority or P may indicate program. These letters and what they stand for will vary between different camera brands.

ISO

The third set of numbers represents the ISO. We recommend that you don't concern yourself with ISO settings yet and keep it on the default setting. ISO will be covered in Chapter 9.

Max Bursts

The number in the square brackets indicates the max-burst capabilities of the camera (the maximum number of images a camera can record in one burst).

Focus Lock

This green dot will appear to indicate that something is in focus. If the green dot is not visible, this indicates that there is no specific point of focus within the image.

Flash Status

This indicates whether on-camera flash will be used to capture the image. If this symbol does not show, it means that the image will be taken without flash.

Focus Point

The points within the frame that the camera can use to autofocus are shown by focus points in the viewfinder. The number and layout of these points will vary from camera to camera.

AE Lock

This indicates the Auto-Exposure Lock function has been enabled. This locks the exposure when shooting and is only relevant if using automatic exposure modes such as Auto, AV or TV.

VERSION ONE:

An example of a typical viewfinder display with the different camera settings and exposure scale shown at the bottom.

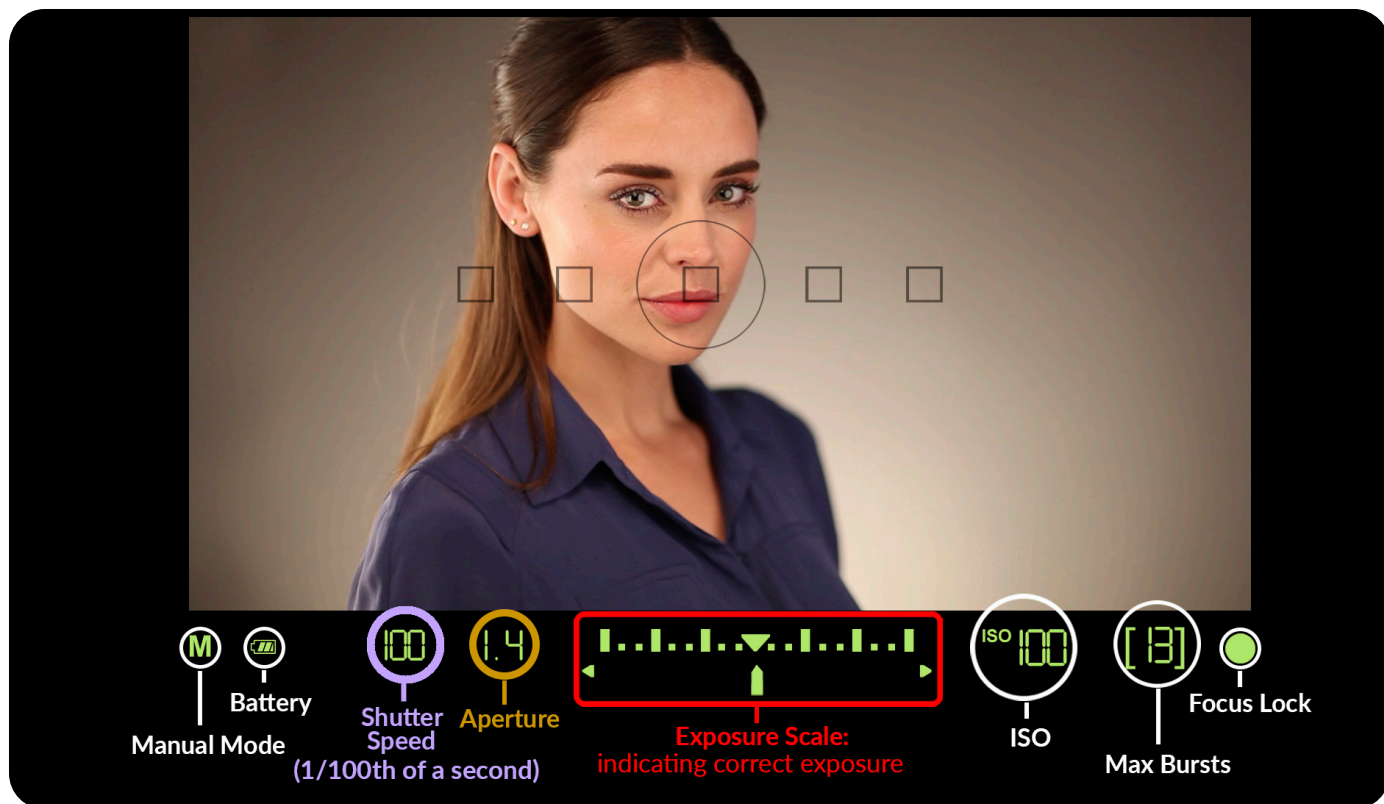

VERSION TWO:

Other viewfinder displays may look slightly different. In this example, you can see the exposure scale on the right, with the camera settings shown at the bottom.

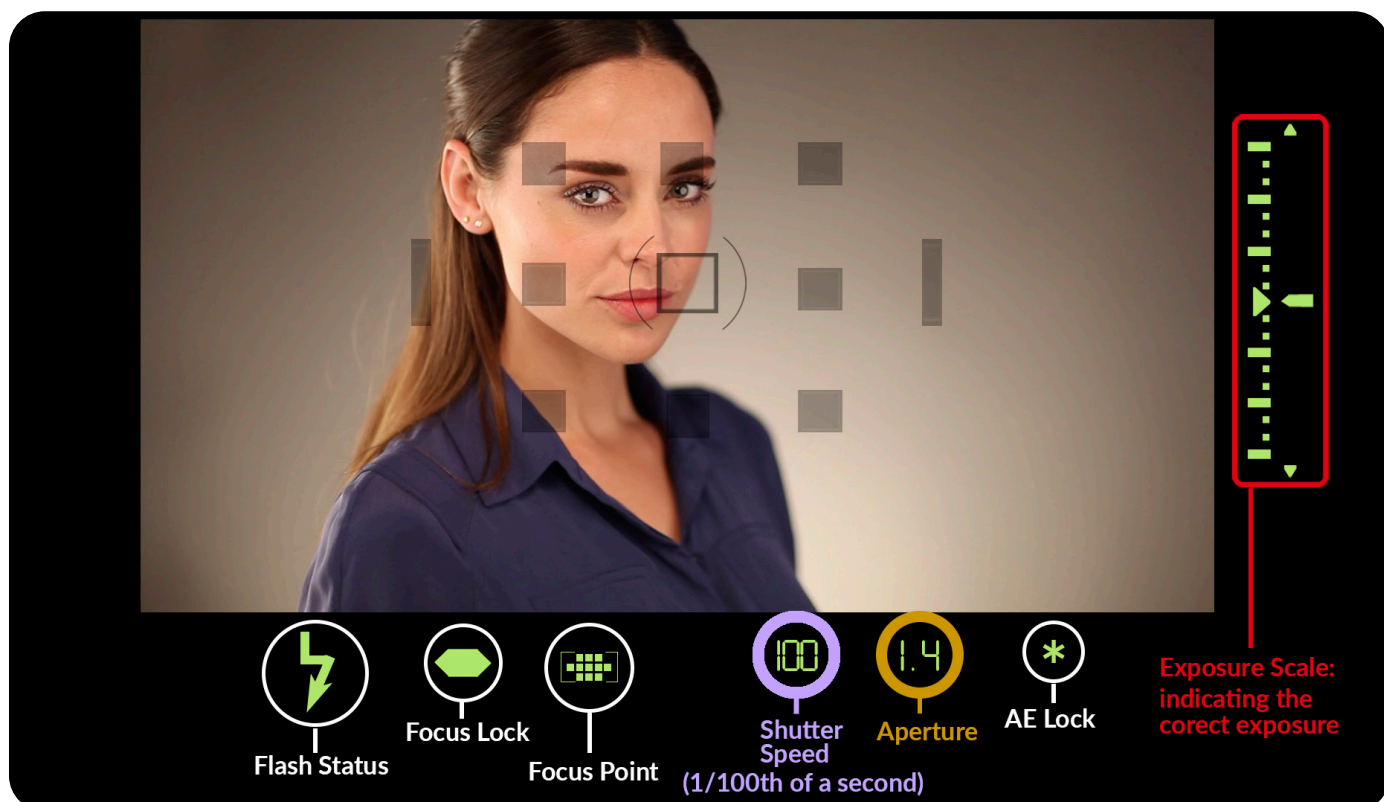

EXPOSURE SEESAWS

When you're trying to find and maintain the correct exposure, visualise exposure as a seesaw. If there is a change in either shutter speed or aperture, the other will have to be adjusted accordingly to maintain a balance. Any adjustment in one that is not matched by the other will result in an unbalanced or incorrect exposure. It is important to

remember that different shutter speed and aperture combinations can result in the same exposure. This doesn't necessarily mean one combination is more correct than the other; it simply means that we can take advantage of the relationship between shutter speed and aperture to achieve different creative results. Let's consider

UNDER-EXPOSED

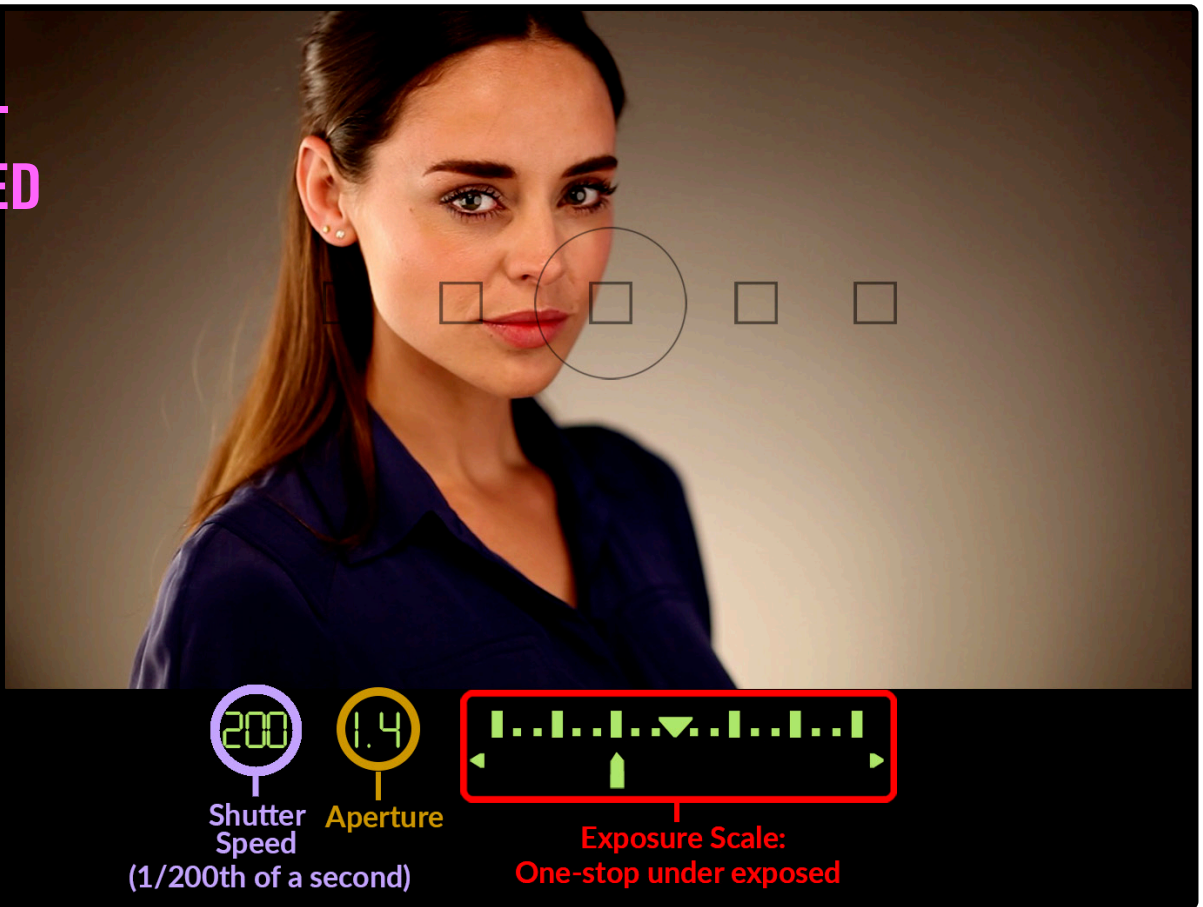

SHUTTER SPEED

↑
1/200
1/100
1/50
1/25
↓

APERTURE (F-STOP)

↑
f 2.8
f 2
f 1.4
f 1
↓

Under Exposed

Here we can see that the combination of 1/200 at f1.4 results in a one-stop underexposed image, indicated by the camera's exposure scale or light meter. This is because this particular combination does not allow enough light to reach the sensor. To correct this, we could either use a slower shutter speed, or open the aperture even further.

UNDERSTANDING EXPOSURE

an example where we might want to maintain the same exposure, but decrease the depth of field. To achieve a shallower depth of field, the aperture needs to be wider. Let's imagine a two-stop change achieves the desired result. This means that to reach the same exposure, the shutter speed would have to increase by two

stops. By increasing the shutter speed, we compensate for the change in the aperture by cutting out the extra light and therefore maintain a balance. If, however, the shutter speed did not change, the final image would have a shallower depth of field, but would be two stops overexposed.

OVER-EXPOSED

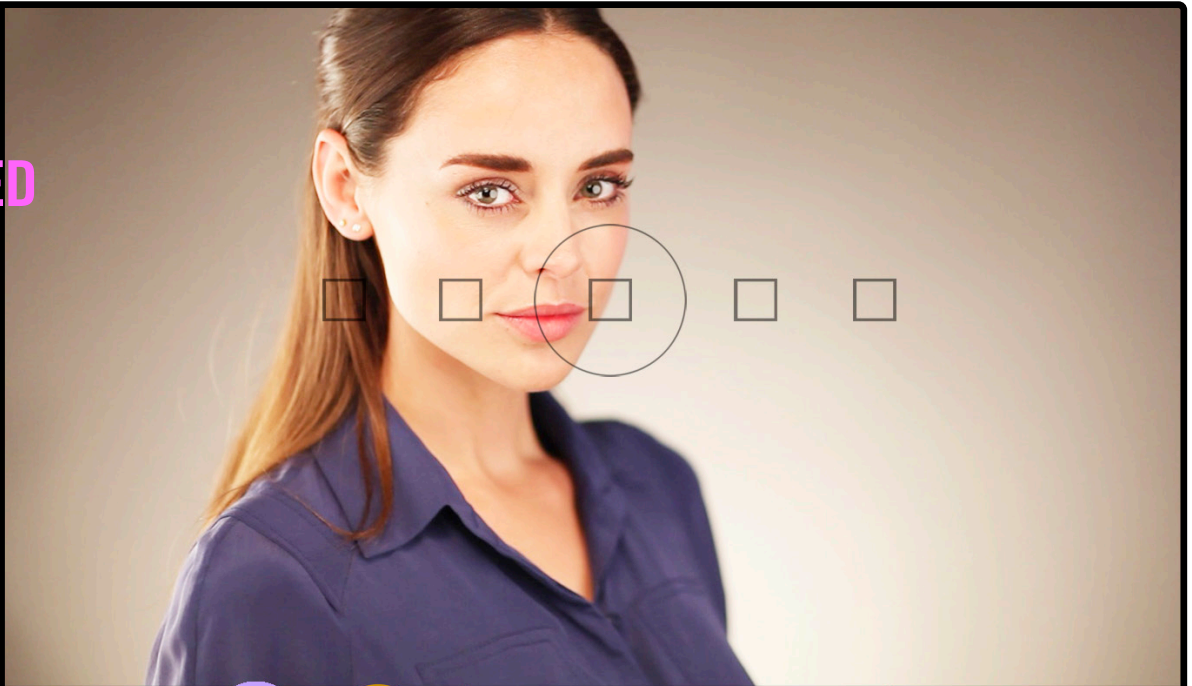

50

Shutter Speed

(1/50th of a second)

f1.4

Aperture



Exposure Scale:

One-stop over exposed

SHUTTER SPEED

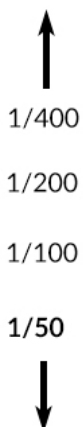

APERTURE (F-STOP)



Over Exposed

In this second example, we can see that by slowing the shutter speed from 1/200 to 1/50 while keeping the aperture at f1.4, it has resulted in an image that is one-stop overexposed. By slowing the shutter speed, more light can be recorded by the sensor and as a result, this change has produced an additional two stops of light.

CORRECT EXPOSURE

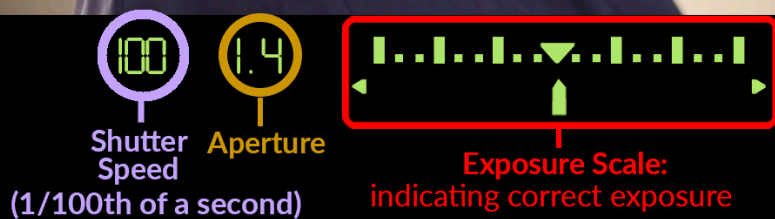
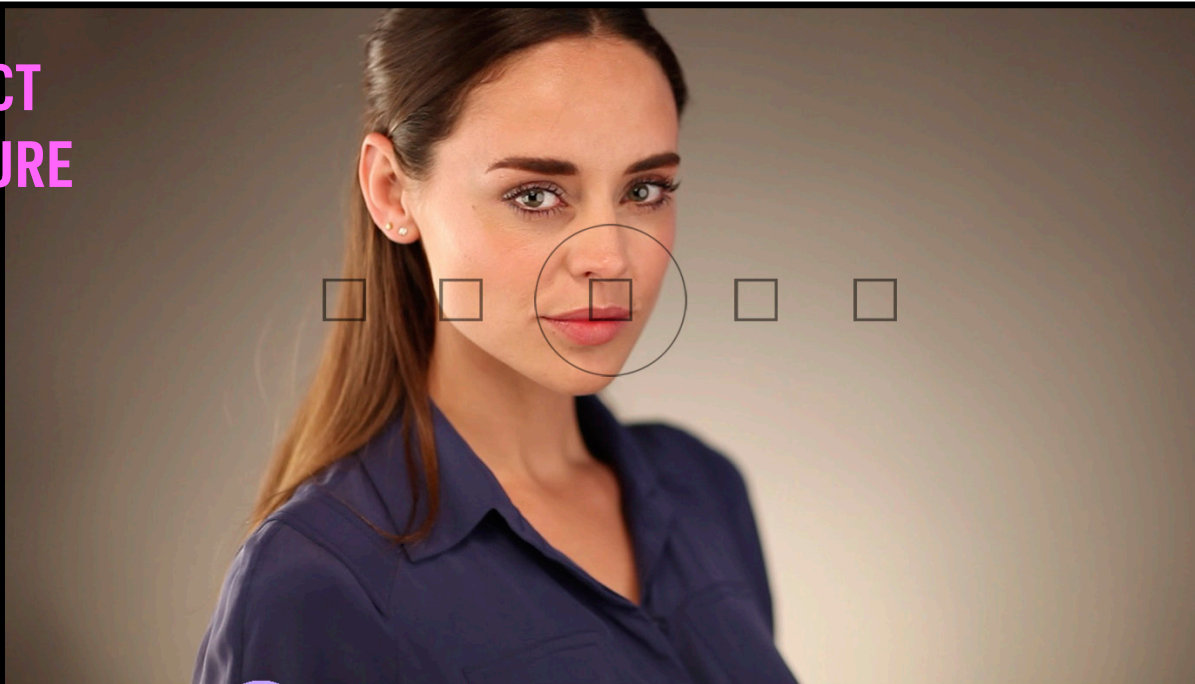

SHUTTER SPEED

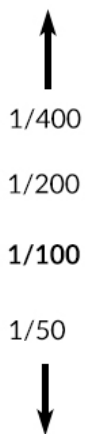

APERTURE (F-STOP)



Correct Exposure

In this example, we can see that a combination of 1/100 at f1.4 has resulted in the correct exposure. This could be determined based on either of the two previously incorrect results. Using the principle of a seesaw, we know the same level of brightness could also be achieved using a combination of 1/25 at f2.8, for example.

CHAPTER SUMMARY

Exposure is an important part of photography, and knowing how to control the brightness or darkness of an image is key to taking control of your camera in Manual mode. Shutter speed and aperture are the two main functions used to control exposure. Any change that results in double or half the amount of light is referred

to as a one-stop change. Understanding this concept is key to getting to grips with exposure. Keeping the 'exposure seesaw' in mind will help you understand how an imbalance in shutter speed and aperture will result in overexposed or underexposed images.

2. WHAT IS EXPOSURE?

Check Your Knowledge

Once you can answer the following questions, you're ready to move on to the next chapter. You can also refer back to the video tutorial [here](#) to learn more or refresh your memory.

- Q1** What does 'underexposure' mean?
- Q2** What amount of exposure change does 'one-stop' relate to?
- Q3** If a picture was 'one-stop' underexposed at 1/250th, what shutter speed would give the correct exposure?
- Q4** If a picture was 'one-stop' overexposed at f11, what aperture setting would give the correct exposure?
- Q5** What part of the viewfinder indicates if you have the correct exposure?

“

**ONCE YOU
UNDERSTAND
EXPOSURE
CHANGES IN
INCREMENTS OF
A STOP AT A TIME,
YOU WILL BETTER
UNDERSTAND
PHOTOGRAPHY.**

”



CHAPTER 3

SHUTTER SPEED



An Introduction to the Six Essentials of Photography
Light • Subject • Optics • Aperture • Time • Recording Medium

SHUTTER SPEED

SHUTTER SPEED SCALE

The shutter speed controls how long we capture light for, as well as how much motion is recorded in an image. Most cameras feature shutter speeds between 1/8000 and

30". When using faster shutter speeds, the shutter remains open for a shorter length of time. This freezes motion but allows less light to be recorded. Slower shutter speeds mean the shutter remains open for longer, blurring motion and allowing more light to be recorded.

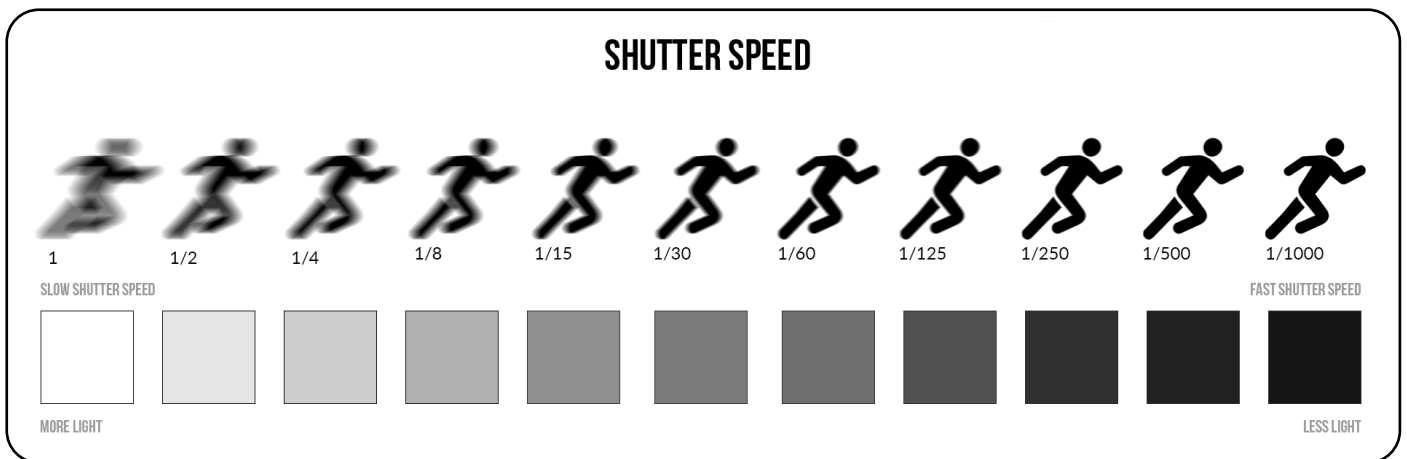

CHANGING THE SHUTTER SPEED

You can manually control the shutter speed when shooting in Manual mode or Shutter Priority using the control dial on your camera.

You can see what shutter speed is set either on the back screen of the camera, the top LCD panel or through the viewfinder.



SHOOTING SPEEDS

The shutter speed controls two creative aspects of photography: the exposure (the brightness or darkness level of an image) and the amount of motion blur captured in an image. Faster shutter speeds mean the shutter remains open for a shorter period of time, which means the sensor has less time to record the light once it's passed through the lens. This results in less light being recorded, which makes faster shutter speeds useful for cutting out additional light in bright, sunny conditions. Faster shutter speeds will also freeze movement and are often used when photographing fast moving subjects like sports or wildlife. When using slow shutter speeds, the shutter remains open for a greater length of time. This not

only allows more light to be recorded by the sensor, it also means any moving objects will appear blurred. Slow shutter speeds are commonly used when photographing in low light conditions or when we want to capture motion blur. This can be used for creative effect when photographing a number of different subjects. Common instances where slow shutter speeds can be used creatively are when photographing star trails or running water like rivers or waterfalls. When selecting the shutter speed it's important to keep both of these factors in mind as they will have a noticeable impact on your final image. Decide if you want to capture more or less light and if you want to freeze or blur your subject.

FAST SHUTTER SPEEDS

An example of where a fast shutter speed has been used to freeze movement can be seen in the image on the right. Thanks to a fast shutter speed, the motorbikes appear completely still. How fast your shutter speed needs to be to freeze movement depends on how fast the subject is moving. A faster shutter speed would be needed for motorbikes compared to, say, a child running.



Discover this : Capturing Action Shots

SLOW SHUTTER SPEEDS

In this example, a very slow shutter speed was used to record an image of the night sky. Using a slow shutter speed meant it was possible for the sensor to record enough light that the stars (and even lights from the nearby city) were visible. Photographing the night sky often requires very slow shutter speeds – anywhere from a couple of seconds up to a few minutes.



Discover this : Spectacular Night Skies

SHOOTING TECHNIQUES FOR CREATIVE EFFECT

When photographing action shots, there are three techniques you can try. The first is to freeze the action and background by using a fast shutter speed. The second is panning, which can be achieved by using a slow shutter

speed while following the subject with the camera. A third technique is capturing motion blur. This can be done using a slow shutter speed while keeping the camera in a static position.

1. FROZEN ACTION

Here the subject appears stationary within the frame. This was achieved using a fast shutter speed of 1/500 while keeping the camera in a fixed position. The result is a motionless image where the subject and the background appear frozen in time.



2. PANNING

When you follow the movement of the subject with the camera while using a slow shutter speed, the subject appears frozen while the background is blurred.



3. MOTION BLUR

In the examples below, motion blur has been created by using slow shutter speeds. In the example of the girl on the bike, a shutter speed of 1/30 has resulted in the subject being blurred as they pass through the frame, but because the camera has remained in a fixed position everything else appears sharp. In the seascape shot, a four-second exposure time allowed the motion of the waves to be captured, but with everything else remaining sharp. Remember motion blur can only be successful when there is no camera shake, so using a tripod is essential.

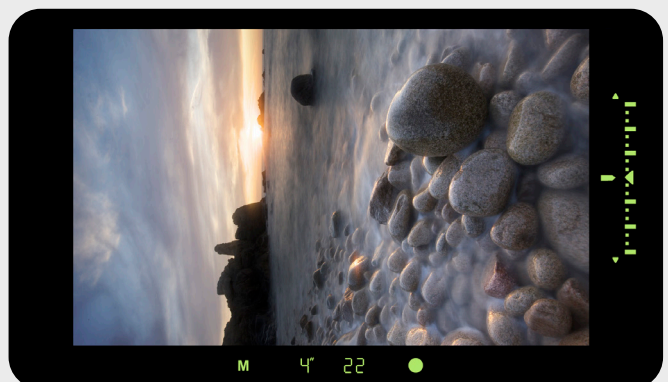

BALANCING EXPOSURE AND SHUTTER SPEED

When creating photos, we may want to use a particular shutter speed to capture a particular amount of motion in an image. In the video you will see Karl shoot a number of examples, demonstrating how to balance exposure and shutter speed. In these examples, an appropriate shutter speed is

used to capture different levels of motion blur. Using these specific shutter speeds, it becomes necessary to use other methods to control and balance the exposure.

UNDER EXPOSED



Here, a shutter speed of 1/30 has allowed us to capture movement using the technique of panning, but at f16, the image is clearly underexposed. This is because the aperture is not allowing sufficient light to reach the sensor. Keeping the same shutter speed, this could be corrected by using a larger aperture.

OVER EXPOSED



In this second example, despite using a larger aperture, there is still an imbalance in the exposure. Using a shutter speed of 1/30 at f8 has resulted in an image that is too bright. Changing to f8 provided two extra stops of light. This was more light than was actually needed and resulted in an overexposed image.

CORRECT EXPOSURE



To achieve the correct exposure at 1/30 we can therefore determine that an aperture between f16 and f8 will balance the exposure. Using our knowledge of the f-stop scale, we know this is f11; and at 1/30 we can see this combination has provided the right level of light and the correct exposure has been achieved.

SHUTTER SPEED, CAMERA SHAKE AND TRIPODS

To get started with photography, you need little more than your camera and a lens. But one piece of equipment that will come in handy is a tripod. You will see numerous instances throughout this course where a tripod is used, and there is a very good reason for this. Generally, when shooting at fast shutter speeds, the short exposure time cuts out any motion blur caused by camera shake; but as this exposure time gets longer, it becomes harder to keep the camera still when taking a picture. This is where a tripod becomes necessary. By using the camera on a tripod, it allows us to fix the camera in position and therefore reduce any unwanted movement. This is especially useful when using exposure times of several seconds. To avoid camera shake when working handheld, use shutter speeds greater than the focal length. For example, if shooting with 200mm, use a shutter speed faster than 1/200.



CHAPTER SUMMARY

Shutter speed refers to the length of time that the shutter remains open for the medium to record light, and is one of the key methods we can use to control exposure. Measured in fractions of a second, most cameras will have shutter speeds ranging between 30" and 1/8000. This can be adjusted simply using the control dial on the camera and can be viewed on the back of the camera, the top LCD panel or through the viewfinder. Slower shutter speeds will record more light while fast shutter speeds will record less light. In addition to controlling the exposure of the image, the shutter speed also determines how much motion is recorded in an image. Slow shutter speeds will create the effect of movement (depending on how much/how quickly the subject is moving) while fast shutter speeds will freeze movement and result in

static-looking images. This is shown in the video through the examples of the cyclist and skateboarder. Slow shutter speeds are therefore often used when photographing in low light or at night or when wanting to create the effect of movement in an image, while fast shutter speeds are often used when photographing in sunny conditions or when wanting to freeze fast moving subjects. Selecting which shutter speed to use depends on what we're photographing and the creative effect we want.

3. SHUTTER SPEED

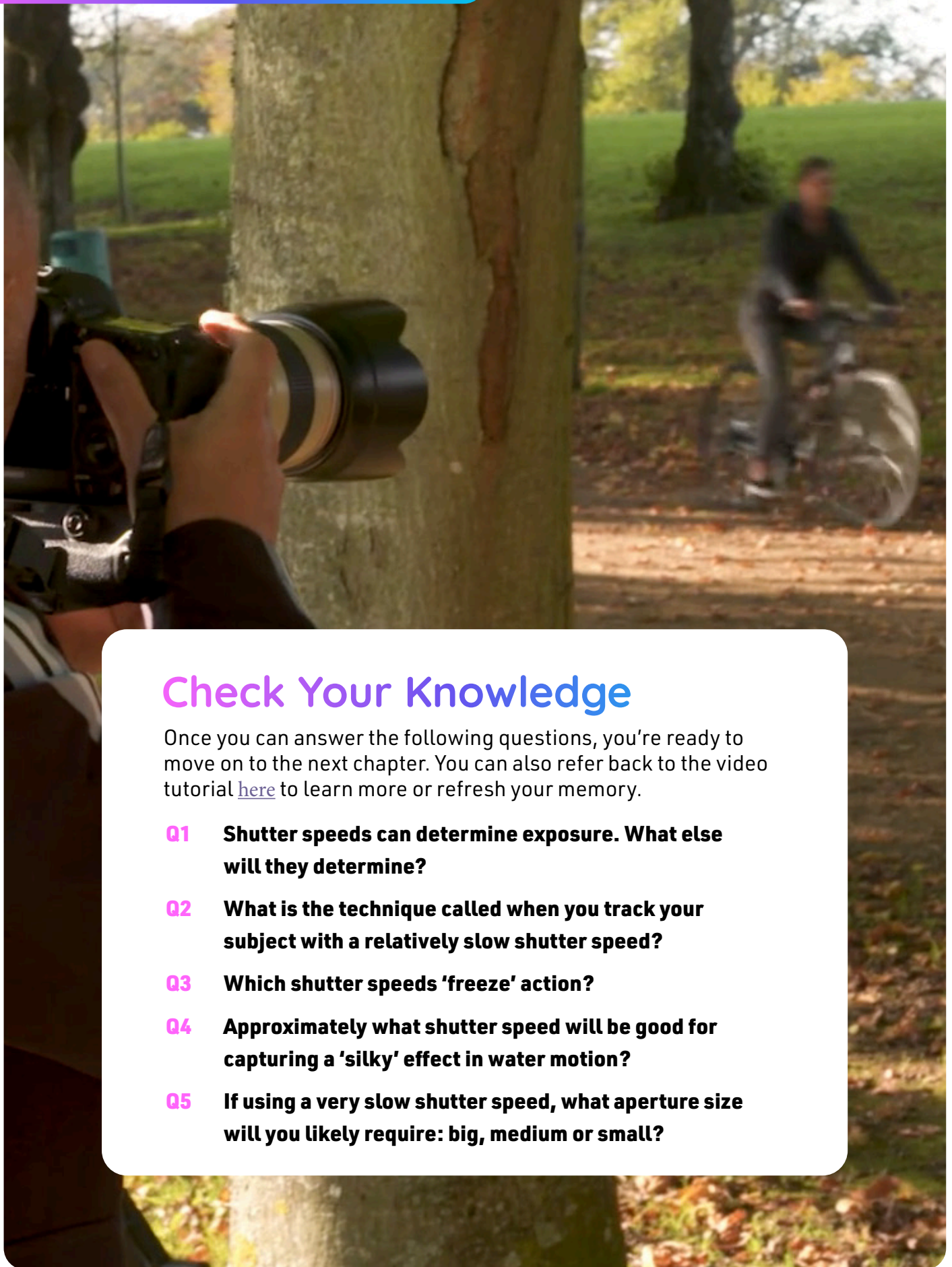

Check Your Knowledge

Once you can answer the following questions, you're ready to move on to the next chapter. You can also refer back to the video tutorial [here](#) to learn more or refresh your memory.

- Q1** Shutter speeds can determine exposure. What else will they determine?
- Q2** What is the technique called when you track your subject with a relatively slow shutter speed?
- Q3** Which shutter speeds 'freeze' action?
- Q4** Approximately what shutter speed will be good for capturing a 'silky' effect in water motion?
- Q5** If using a very slow shutter speed, what aperture size will you likely require: big, medium or small?



“

**BY USING
LONG SHUTTER
SPEEDS, WE
OPEN UP MORE
CREATIVE
OPPORTUNITIES.**

”



4

CHAPTER

CAMERA FOCUS



An Introduction to the Six Essentials of Photography
Light • Subject • Optics • Aperture • Time • Recording Medium

CAMERA FOCUS

ADJUSTING THE FOCUS

When you're taking a photo, at least a part of the image must be in focus. You can adjust the focus of an image manually or automatically.

When using manual focus, you rotate the focus ring on the lens until the area you want to be in focus becomes sharp.

When using autofocus, there are two factors to understand: focus points and focus modes. Focus points are the squares you see in the viewfinder when framing the image. These determine where the point of focus in an image will be. Using autofocus, the camera can automatically select the focus point(s) or you can select the focus point yourself.

The other factor to consider is the focus mode. This is what determines how the autofocus works while the shutter button is half pressed. Focus modes vary between cameras, but most will have at least two: either a single-shot focus mode or a continuous focus mode. The single-shot focus mode keeps the focus point locked once the shutter is half pressed, even if you reframe the image. Continuous focusing continuously recalculates and readjusts the focus until the image is taken.

Camera focus modes

	Advantages	Disadvantages
Manual Focus	<ul style="list-style-type: none">• More accurate in low light conditions• Useful in situations where there is low contrast• Good for scenes that are busy and confusing when your camera doesn't know what to focus on	<ul style="list-style-type: none">• Can be slower to manually focus• Can be difficult to get focus correct• Time consuming when having to recompose and refocus often
Autofocus	<ul style="list-style-type: none">• Quick• Different autofocus options for different situations• Good for scenes that are often changing (like sport or wildlife photography)	<ul style="list-style-type: none">• Can be difficult to use in low light conditions• Can be difficult to use in scenes with low contrast• Not always accurate in busy or confusing scenes

AUTOFOCUS

Autofocus is a great option for those still getting to grips with their camera as it is a quick and easy method of focusing. Using autofocus, it is possible to select different focus modes. These include 'Single-shot/Single-servo' focus mode, where one focus point is used to determine focus (this does not change until you re-focus or take the image), or 'Continuous focusing/Continuous-servo', where the camera continuously readjusts the focus for as long as the focus button is held down.

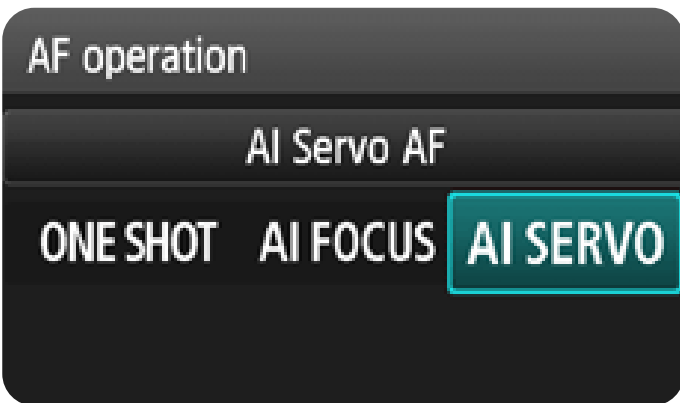

MANUAL FOCUS

Manual focus gives you a far greater level of control in deciding where the focal point in an image should be. It can be particularly useful in situations where the camera has difficulty auto-focusing (such as in low-light conditions or when the background is very busy) or when taking a series of images where you don't want the focus point to change.



CAMERA CONTROLS

Initial focus can be achieved by pressing the shutter button halfway down. This focuses the lens according to which focus point is selected. To adjust these points, use the control wheel or buttons on the camera (some cameras have a joystick on the back for this) or in the menu system. Some cameras also have 'back button' focusing that allows you to control the focus without pressing the shutter button.



SELECTION POINTS

Looking through the viewfinder, you will see a number of small squares in front of the image. These are focus selection points, which the camera uses to determine the point of focus. Different cameras have different numbers of selection points, as well as different layouts of these points. These points make up what is referred to as the autofocus area and can be changed automatically by the camera or manually by the photographer using the controls mentioned in 'Camera Controls'.

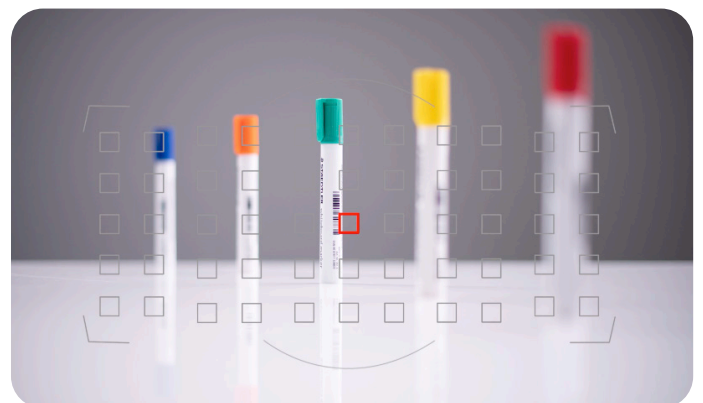

SELECTING YOUR FOCAL POINTS

Whether you're photographing landscapes or portraits, the key is to have the focus selection point over the area that you want to be sharp. In the video you can see how the focus points are changed to shift the focus to

different areas within the image. Where we choose to focus within an image can have a big impact (especially when using large apertures), so it's important to choose the best focus point.

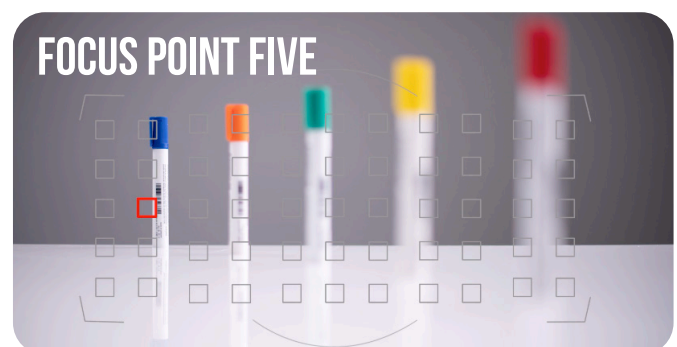
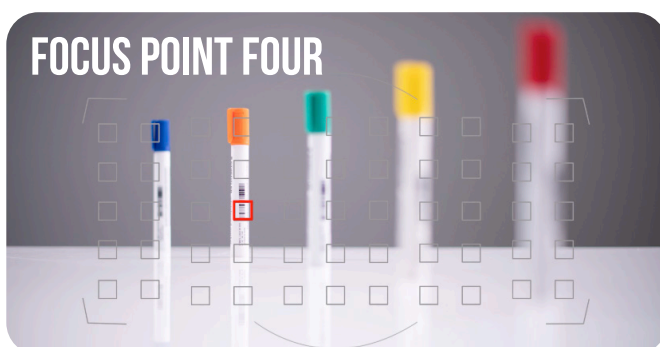
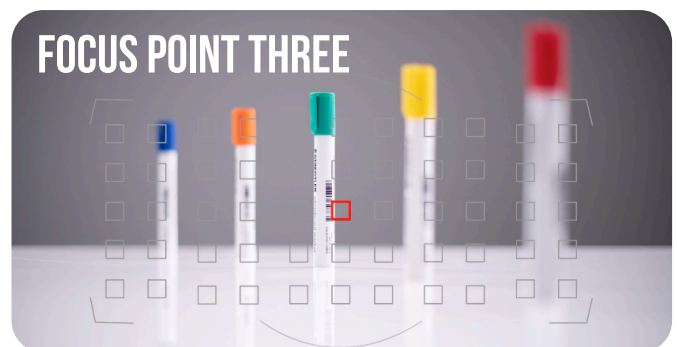
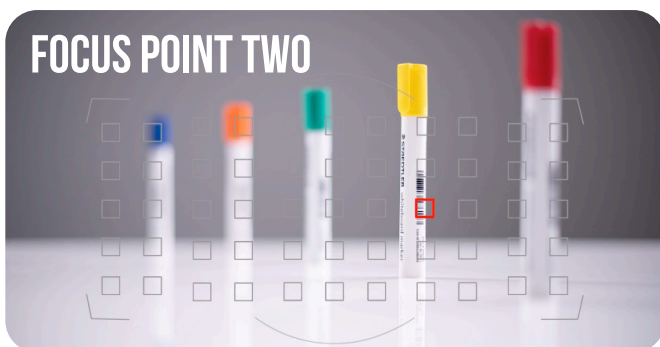
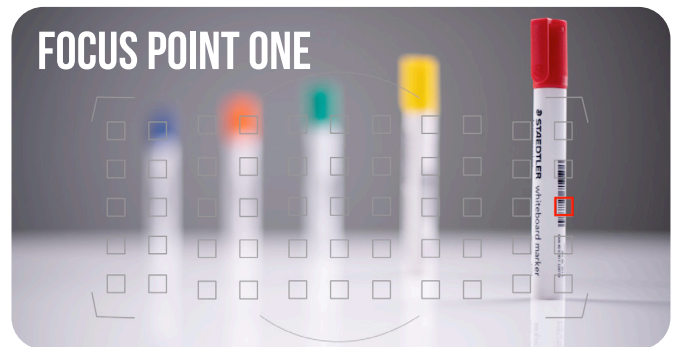

CHAPTER SUMMARY

Focus is an important concept to understand in photography as it can make or break an image. With most camera lenses we now have the option to choose between manual focus and autofocus, both of which have their

advantages and disadvantages. When using autofocus, the two most important concepts to understand are focus points and focus modes. Focus points can be selected automatically or manually, and where these focus points are within an image can have a great bearing on how the final image looks.

4. CAMERA FOCUS

Check Your Knowledge

Once you can answer the following questions, you're ready to move on to the next chapter. You can also refer back to the video tutorial [here](#) to learn more or refresh your memory.

- Q1** How does autofocus work?
- Q2** What does 'MF' mean on your camera or lens?
- Q3** What do the markings in meters and feet indicate on a lens?
- Q4** Using your camera, how can you choose where to focus in an image?
- Q5** Which focus mode would you use for a subject moving towards you?



“

**IT MATTERS
LITTLE HOW MUCH
EQUIPMENT WE
USE; IT MATTERS
MUCH THAT WE BE
MASTERS OF ALL
WE DO.**

”



CHAPTER

5

APERTURE AND DEPTH OF FEILD



An Introduction to the Six Essentials of Photography
Light • Subject • Optics • Aperture • Time • Recording Medium

APERTURE AND DEPTH OF FIELD

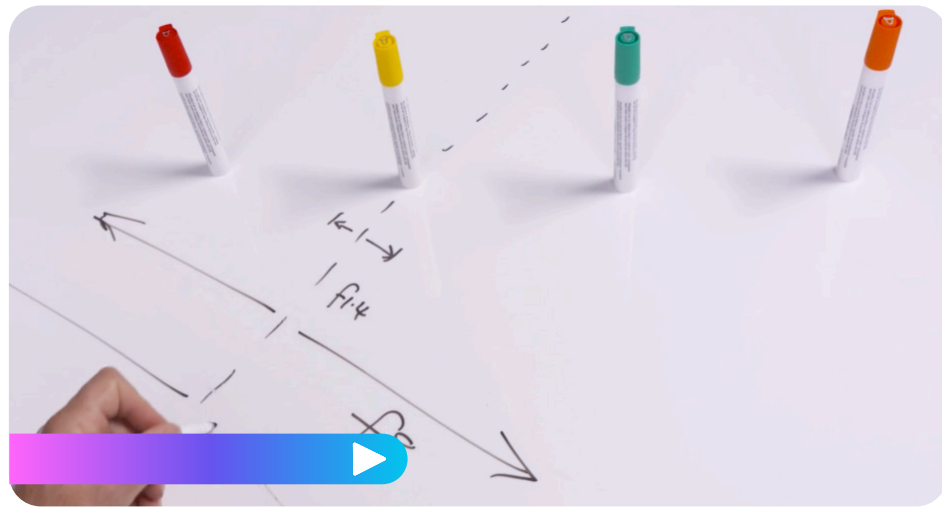

HOW TO CHANGE THE DEPTH OF FIELD

The aperture refers to the opening in the lens through which light passes before reaching the medium. This controls not only the amount of light recorded in an image, but also the depth of field – the sharpness range either side of a focus point. Adjusting the aperture is the easiest way to control the depth of field. Larger apertures, like

f1.2, reduce the depth of field, while smaller apertures, like f16, increase depth of field. Using the control wheel on the camera to adjust the aperture, we can change the depth of field. There are other factors that also influence depth of field though. These include the distance from the subject, magnification and sensor size.

APERTURE

SIZE

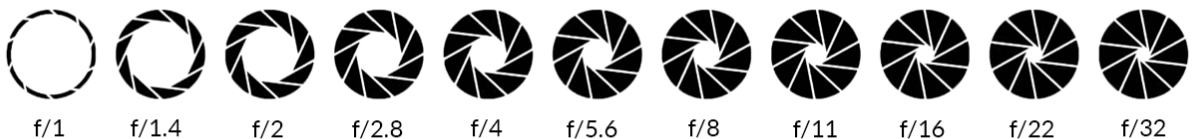

LARGE APERTURE

SMALL APERTURE

DEPTH OF FIELD



SHALLOW DOF

GREAT DOF

LIGHT

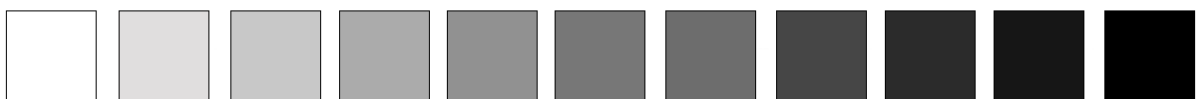

MORE LIGHT

LESS LIGHT

CREATIVE EFFECTS OF APERTURE

By controlling the aperture, we can control the exposure of an image as well as the depth of field. Adjusting the depth of field is one of the easiest ways to get creative in photography, but it's important to understand how aperture works and how this relates to depth of field. Larger apertures, such as f1.2, allow more light to pass through the lens and reach the sensor and result in a much shallower depth of field. This means only a small part of the image will be sharp, with the remainder appearing blurry (this blurred effect is often referred to as 'bokeh'). Larger apertures are typically used in instances where we want to focus on just a small part of the image – for example, a bee on a flower or the eyes of a person. Smaller apertures allow less light to pass through the lens, which, if not balanced with the shutter, can result in darker images. They also allow for greater depth of field, which makes them ideal for shooting landscapes, or images where we want detail in the background. Another

creative effect that can be achieved by adjusting the aperture is what is the so-called starburst effect. This occurs when photographing focused light sources (such as a street lamp or the sun) using a small aperture. This reduced aperture causes light to reflect off the blades of the aperture, resulting in a starburst effect on the light source. (Find an example of this in Chapter 3: the skateboarder image).

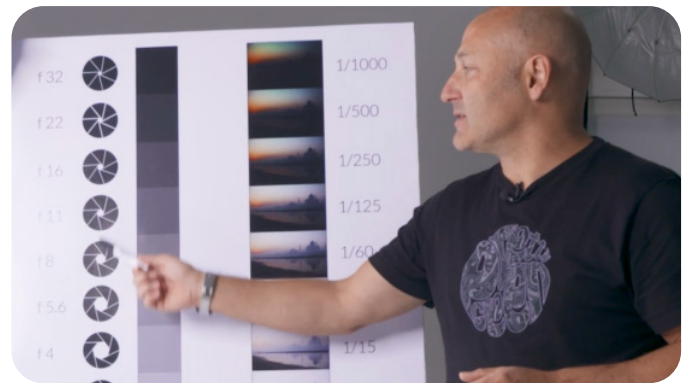

SMALL APERTURE: F22

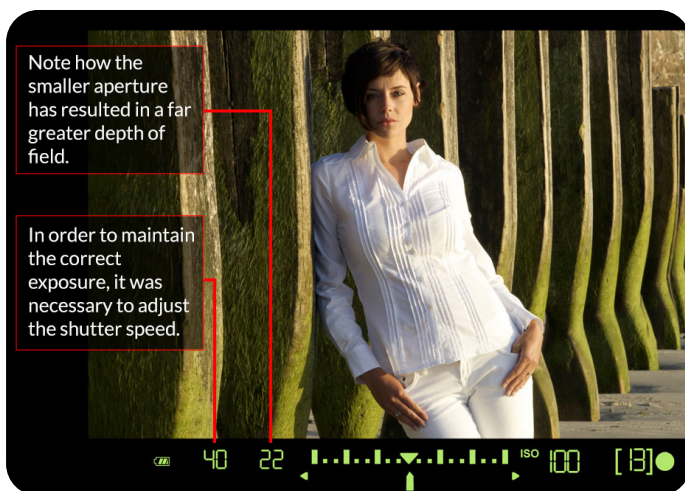

In this example, a small aperture of f22 has resulted in a large depth of field, where both the subject and poles in the background are sharp. Small apertures like this are not often used when photographing people because the large depth of field can make the final image too 'busy'.

LARGE APERTURE: F2.8

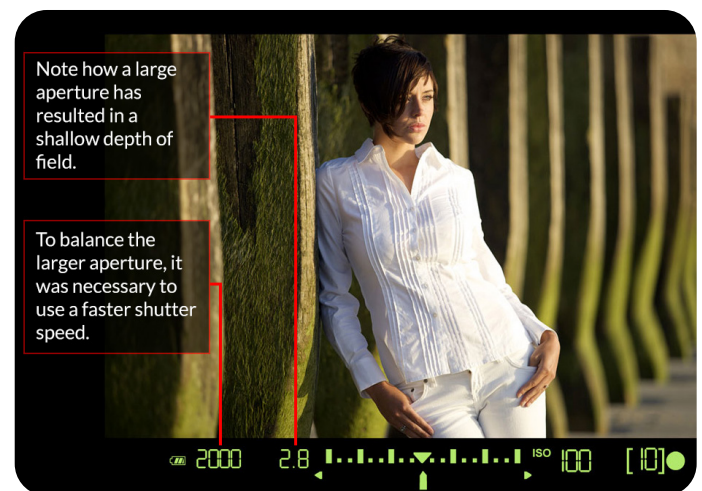

Here, a shallower depth of field, achieved using an aperture of f2.8, has resulted in a much better result. Using large apertures is common when photographing people as it helps to create separation between the model and the background.

BALANCING EXPOSURE AND DEPTH OF FIELD

Aperture can be used to control depth of field and balanced with shutter speed to achieve the correct exposure. Depending on what you want to achieve with the image, it may be necessary to change either the shutter speed or the aperture. In the following examples you can see how once we've achieved the desired depth of field, it is necessary to adjust the shutter speed to balance the exposure. In any situation

where depth of field is a priority, you must change the shutter speed to find the correct exposure. For example, at f22 an image may be too dark, which means it may be necessary to use a slower shutter speed to allow in more light. Likewise, using a large aperture may result in an overexposed image, which means a faster shutter speed may be needed.

SHOT ONE

Large aperture and fast shutter speed



Using a large aperture of f1.4 with a very fast shutter speed of 1/640 has resulted in the correct exposure. The wider aperture achieves a shallow depth of field, hence only the yellow pen is sharp. In addition, a faster shutter speed, which does not allow very much light to be recorded by the medium, balances the exposure.

SHOT TWO

Medium aperture and fast shutter speed

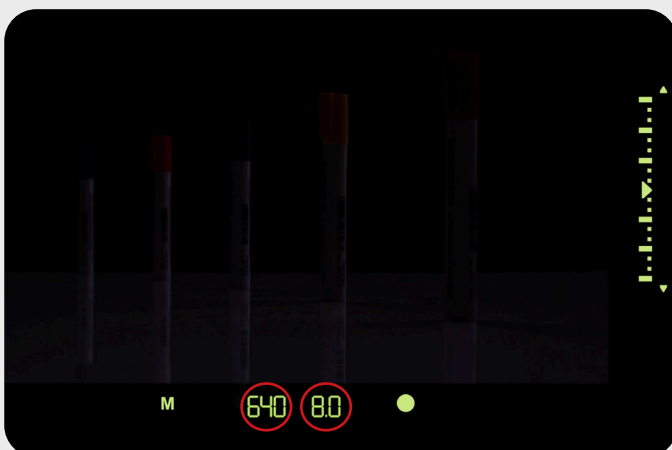

We have used the same fast shutter speed of 1/640 but closed the aperture by five-stops, to f8. This has resulted in an underexposed image because both the fast shutter speed and medium aperture limit the amount of light recorded by the medium. To allow in more light while maintaining the same depth of field, we would need to use a slower shutter speed.

SHOT THREE

Medium aperture and slow shutter speed

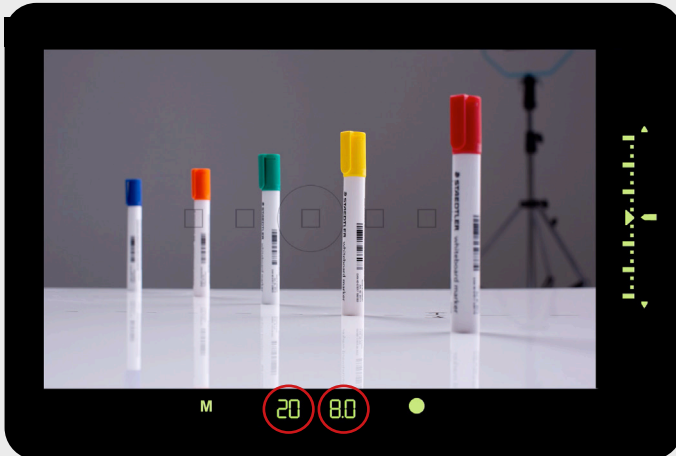

Using the same aperture of f8, we have achieved the correct exposure by using a much slower shutter speed. By reducing the shutter speed from 1/640 to 1/20, we have increased the amount of light by five-stops to achieve the correct exposure. This setting combination has resulted in the same exposure as shown in the first example, but with a far greater depth of field.

SHOT FOUR

Small aperture and slow shutter speed



A different setting combination has resulted in the same exposure, but this time with an even larger depth of field. We achieved this by using a small aperture of f16 and a slow shutter speed of 1/5. By decreasing the size of the aperture, it becomes necessary to use a slower shutter speed to compensate for the loss of light caused by the aperture change.

CHAPTER SUMMARY

Aperture adjustments allow you to control both the exposure and depth of field of an image. Large apertures like f2 result in more light and shallow depth of field, while smaller apertures like f16 result in less light and larger depth of field. Large apertures are often used to photograph people as they help separate the subject from the background. Small apertures are popular

for landscapes because of the larger depth of field. The aperture can also be used together with the shutter speed to achieve the correct level of exposure in an image.

5. DEPTH OF FIELD

Check Your Knowledge

Once you can answer the following questions, you're ready to move on to the next chapter. You can also refer back to the video tutorial [here](#) to learn more or refresh your memory.

- Q1** What two things happen as you decrease the size of the aperture?
- Q2** Describe depth of field.
- Q3** If $1/1000$ th and $f2.8$ is the correct exposure, what would be the correct shutter speed for $f8$?
- Q4** Why is shallow depth of field often used for portraits?
- Q5** Other than aperture settings, what is the key factor that determines depth of field?



“

A CAMERA DIDN'T
MAKE A GREAT
PICTURE ANY
MORE THAN A
TYPEWRITER
WROTE A GREAT
NOVEL.

”



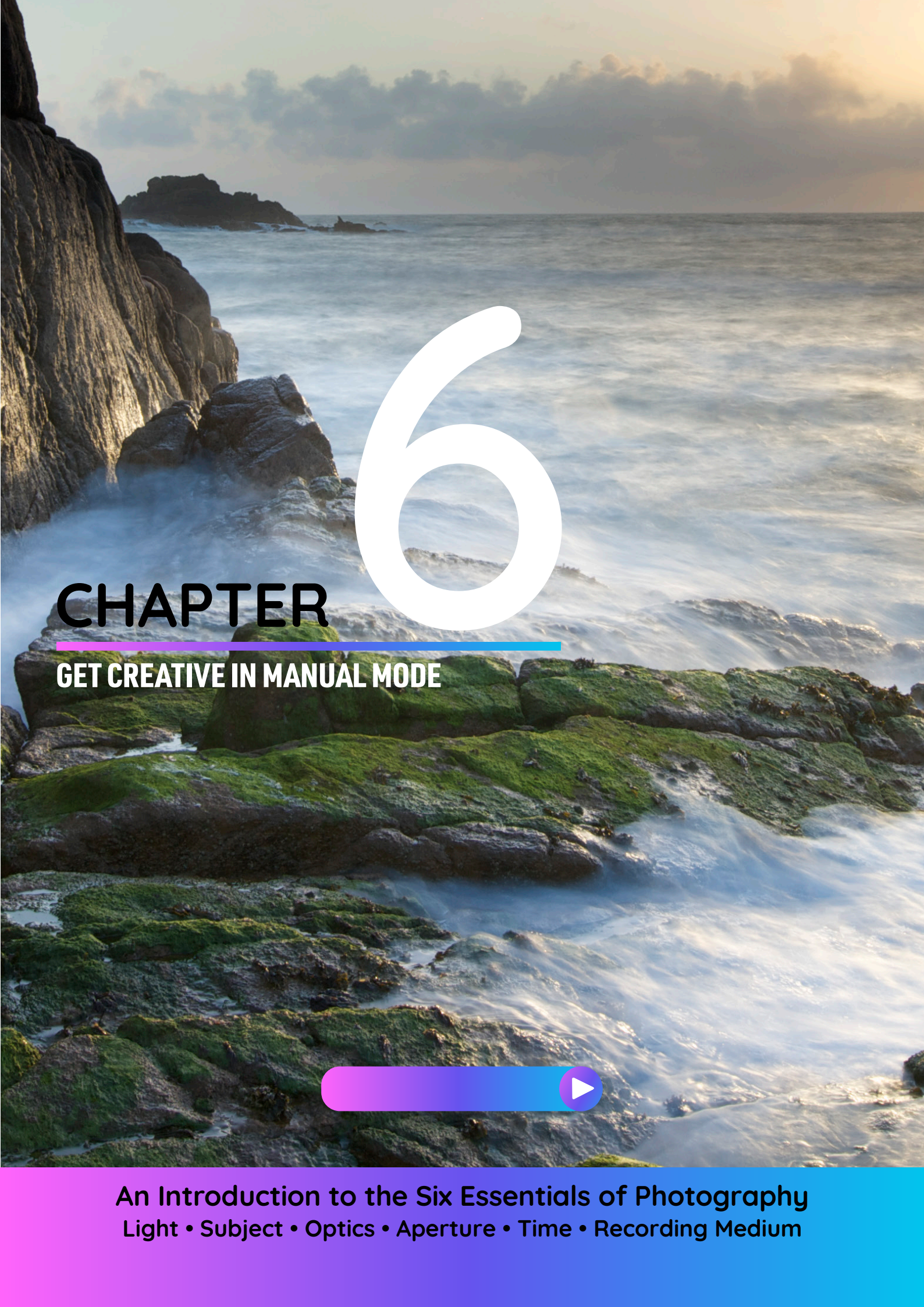

6

CHAPTER

GET CREATIVE IN MANUAL MODE



An Introduction to the Six Essentials of Photography
Light • Subject • Optics • Aperture • Time • Recording Medium

GET CREATIVE IN MANUAL MODE

MANUAL MODE

Shooting in Manual mode may seem daunting at first. But mastering it is crucial if you want to advance your photography. In this chapter, Karl explains his camera settings while shooting a seascape. He battles with changing light,

maintaining depth of field and capturing the desired amount of motion in the waves. Overcoming challenges like this is all part of the fun of Manual mode.

EARLIER SHOT: MORE AVAILABLE LIGHT



In the video in this chapter you will see as Karl sets out to photograph a seascape sunset. Throughout the shoot he experiences changing levels of light as the sun sets lower in the sky and he demonstrates how, by using Manual mode, you can more easily adapt to light changes in your environment while still achieving the creative results desired.

LATER SHOT: LESS AVAILABLE LIGHT



Early on in the shoot, the sun was still fairly high in the sky, as seen on the left. The aperture of f16 allowed for a large depth of field. The slower shutter of 4 seconds allowed Karl to capture enough light as well as some motion. With these settings, he was able to achieve the correct exposure.

However, later in the shoot, as shown on the left, the sun had dropped in the sky. Wanting to keep the same exposure time to capture the desired amount of motion in the water, adjusting the shutter speed was not an option for Karl to correct the exposure, so he opened the aperture by one third of a stop to f14 instead, to increase the exposure.

WHAT YOU CAN ACHIEVE IN MANUAL MODE

Shooting in Manual mode requires you to find a balance between shutter speed and aperture to achieve the correct exposure. What you can achieve with just these two settings is limitless. Light painting at night? No problem. Silky smooth water for a crashing

waterfall? Easy. Moody portraits with shallow depth of field? Simple. In this chapter, Karl touches on just a few of the things you can achieve when shooting in Manual mode. The truth is that these examples are just the start. Your imagination is the only real limit. To

LIGHT PAINTING WITH A LONG EXPOSURE

Light painting is a creative technique that looks far more complex than it actually is. This is where light is 'painted' into the photograph using an additional light source while shooting with a long exposure. The key is a slow shutter speed that allows you to record the extra light being 'painted' into the scene. This can require very long exposures – the image on the right was taken over 18 minutes! Light painting is a great way to get creative and try something new. It requires much more than your camera, a tripod and a powerful torch. (For longer exposures, a shutter release cable can also be useful).



Discover this : Painting With Light

CREATIVE EXPOSURE FOR PORTRAITURE

Manual mode enables you to create results that you wouldn't otherwise be able to achieve using any of the automatic or semi-automatic modes on a camera. This portrait is a great example. The dark, moody lighting is exactly what the photographer intended, but it would have been very difficult to achieve using Auto mode. Why? Because the camera would have perceived this as 'underexposed' and either lowered the shutter speed or opened the aperture to add more light.



Discover this : Lighting Theory

achieve the creative images you've always imagined, the key things to remember are shutter speed and aperture, the effects of each and how they can be balanced to achieve the correct exposure. And the fastest way to learn this is to go out and practice in Manual

mode. Below are just a few examples of creative ideas you could try.

BLURRED BACKGROUND

Shallow depth of field is a common choice when it comes to portrait photography. It helps to draw the focus to your subject and make them stand out, which can be particularly useful when photographing against a busy backdrop. To achieve shallow depth of field, you can use large apertures such as f1.2 or even f2.8. (Remember that magnification, distance from the subject and sensor size also have an impact on depth of field). This particular image was shot at f2.8, which has helped create a beautiful soft background with shallow depth of field.



Discover this : Bluebell Woods Shoot

LARGE DEPTH OF FIELD

Wide apertures are a popular choice for portraits, but they are not the only option. Sometimes using a small aperture for greater depth of field can produce an equally interesting result, as you can see here. This is particularly relevant when photographing scenes where we want the background, as well as the subject, to be sharp. Remember it is not only the aperture that controls depth of field, and in this case, by using a wide-angle lens (covered in chapter seven of the course), we ensure the city buildings behind the subject remain sharp. This is due to the magnification of the image and the distance of the subject from the camera.



Discover this : Stunning Location Lighting

LANDSCAPE PHOTOGRAPHY: HOW TO MAXIMIZE DEPTH OF FIELD

The simplest way to increase depth of field when photographing your subject is to use a small aperture. However, there are other ways to maximise the depth of field. Later

in the course, Karl will introduce you to the different characteristics lenses have when it comes to depth of field. For example, lenses with longer focal lengths, like telephoto and super-telephoto lenses, have less depth of field than wide-angle lenses (when using

HYPERFOCAL DISTANCE

Understanding hyperfocal distance will help you select a focus point that maximises the depth of field in both directions in a shot. Focusing in the centre of a shot will not maximise sharpness in the foreground and background, since focal distance works in such a way that depth of field stretches one third of the way in front of the focus point (towards the camera) and two thirds of the way backwards (away from the camera). If used correctly, hyperfocal distance will place the furthest point of sharpness at its maximum potential at that given aperture.

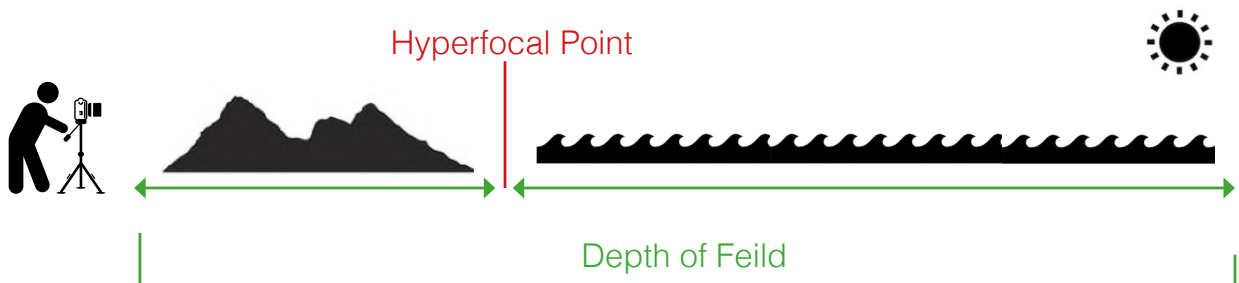

the same aperture). Another factor to consider when maximising depth of field is the hyperfocal distance. Understanding hyperfocal distance allows you to maximise the depth of field available (from the aperture setting that has been selected) through a

considered placement of your focal point. Used correctly, this will allow you to capture images that are sharper throughout.

HYPERFOCAL DISTANCE (CONTINUED)

Here is another example of hyperfocal distance. In the video, you will see Karl demonstrate how to capture an image where the pens are sharp throughout by finding the optimal focal point when using a smaller aperture. Since the depth of field stretches twice as much behind the focus point as it does in front, placing the focus point on the yellow pen allows the depth of field to run from the front to the back pen when using an aperture of f16.

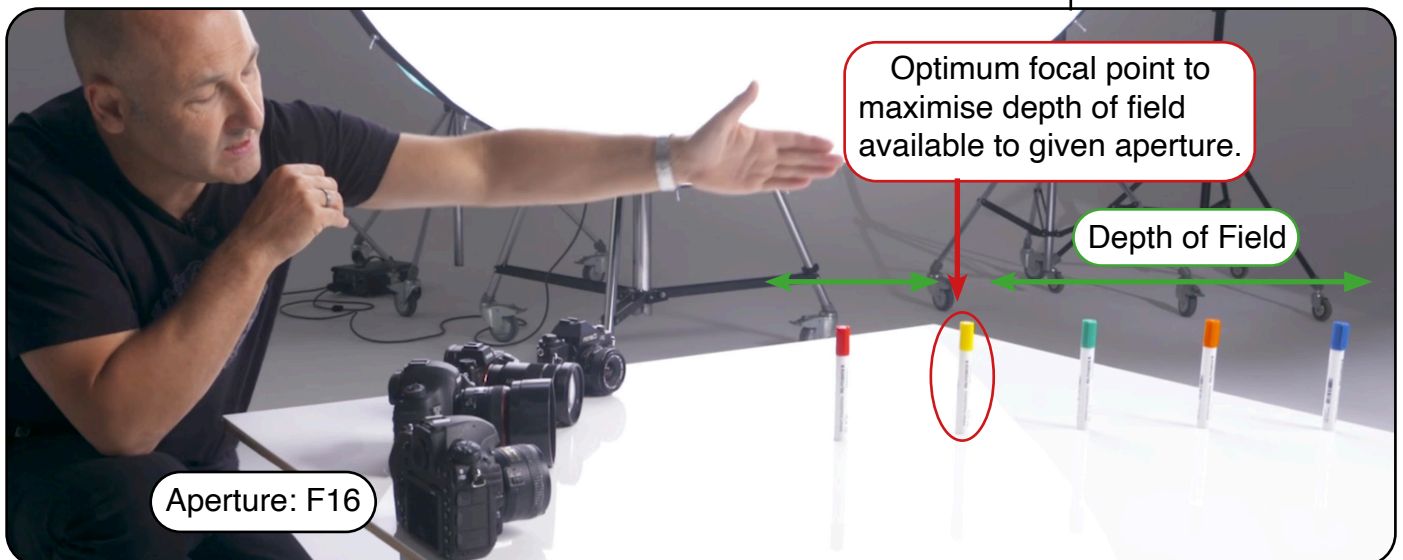

CHAPTER SUMMARY

The advantages of shooting in Manual mode are endless. It allows you to develop a far greater understanding of how your camera works and how to balance exposure. It also gives you the creative freedom to take photos that otherwise wouldn't have been possible

using an automatic or semi-automatic mode. Manual mode can take a little time to get used to, but it will be worth it. Only by shooting in Manual mode will you be able to make the most of your creativity and take your photography to the next level.

4. CAMERA FOCUS

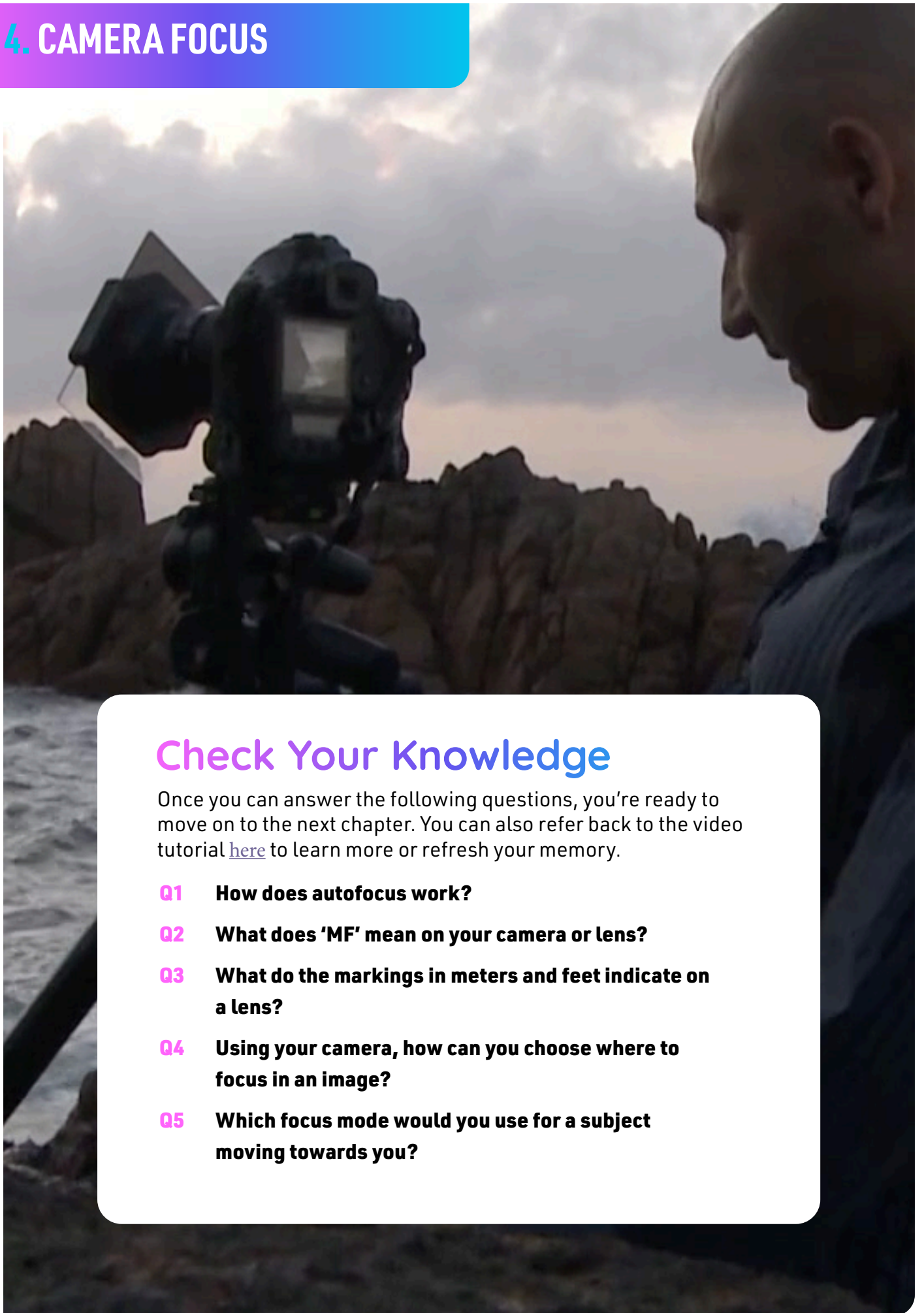

Check Your Knowledge

Once you can answer the following questions, you're ready to move on to the next chapter. You can also refer back to the video tutorial [here](#) to learn more or refresh your memory.

- Q1** How does autofocus work?
- Q2** What does 'MF' mean on your camera or lens?
- Q3** What do the markings in meters and feet indicate on a lens?
- Q4** Using your camera, how can you choose where to focus in an image?
- Q5** Which focus mode would you use for a subject moving towards you?



“

**YOU CAN ONLY
TRULY GET
CREATIVE WITH
PHOTOGRAPHY
ONCE YOU HAVE
MASTERED YOUR
CAMERA IN
MANUAL MODE. I
BELIEVE NO OTHER
COURSE WILL
ADVANCE YOUR
KNOWLEDGE AS
QUICKLY.**

”



7

CHAPTER

OPTICS AND LENSES

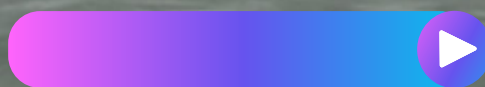

An Introduction to the Six Essentials of Photography
Light • Subject • Optics • Aperture • Time • Recording Medium

OPTICS AND LENSES

UNDERSTANDING LENSES

Lenses are an important part of the photographic process as their unique characteristics are, in part, what determine the look and feel of an image. As light reflected off of the subject enters the lens, it passes through a number of elements, as well as the aperture, before passing through the shutter and reaching the sensor. These lens elements are what serve to focus

the light so that it can be recorded by the medium. The arrangement of these elements determine the focal length of an image, the angle of view, the magnification and help describe the image based on their particular characteristics. Available in a variety of different focal lengths, different lenses produce very different results depending on the configurations within the lens barrel.

INTERNAL WORKINGS OF A CAMERA

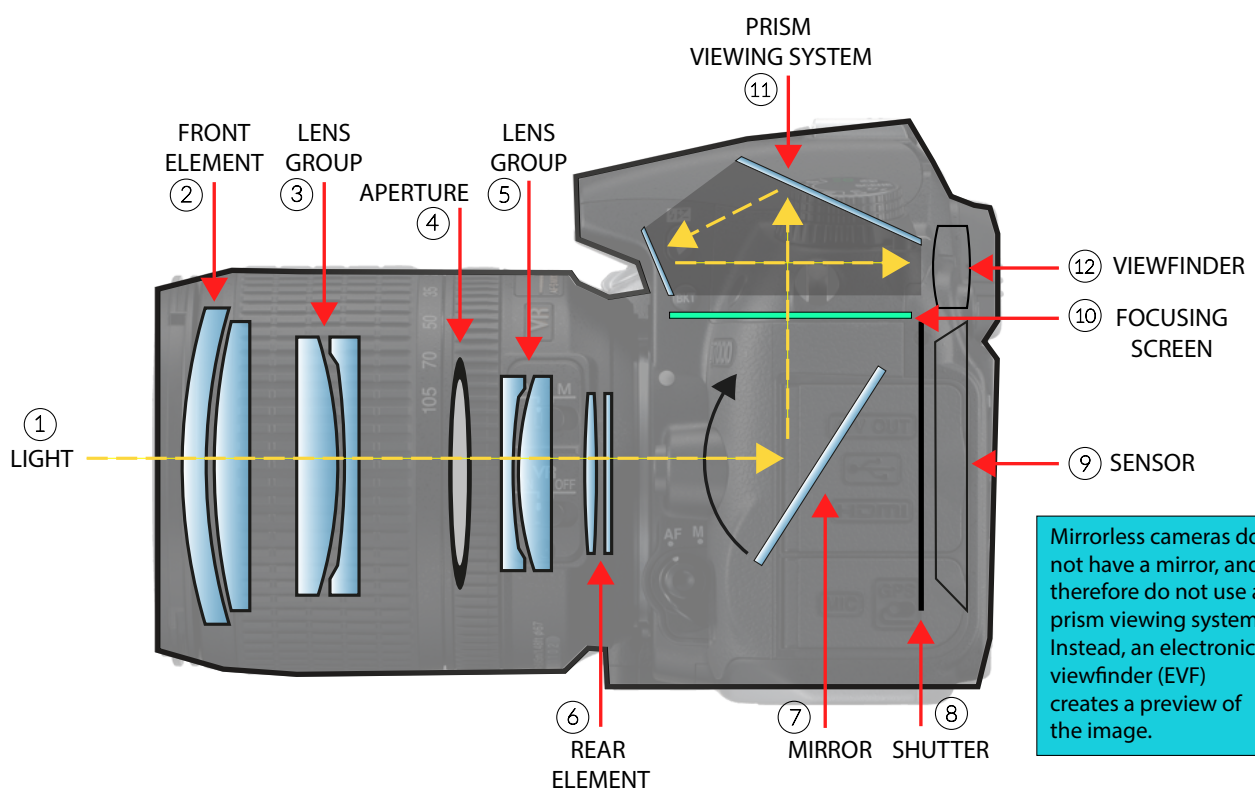

CAMERA LENSES

Lenses come in a variety of different shapes, sizes and focal lengths. Each can be used to create particular results, depending on their particular characteristics. There are two main types of lens – prime or zoom lenses, both of

which come in different focal lengths. Prime (or fixed) lenses feature a fixed focal length and are known for delivering high quality images. They also generally offer much wider apertures compared to zoom lenses. Zoom

LENS TYPES

WIDE ANGLE



Focal length:
8mm - 35mm

Angle of view:
180° - 63°



STANDARD



Focal length:
35mm - 85mm

Angle of view:
63° - 28°



TELEPHOTO



Short Telephoto
Focal length:
85mm-135mm

Angle of view:
28° - 12°

Telephoto
Focal length:
135mm-200mm

Angle of view:
18° - 12°



SUPER TELEPHOTO



Focal length:
200mm - 800mm

Angle of view:
12° - 1°



CHOOSING A LENS

Lenses play an important role in photography – arguably even more important than your choice of camera. So choosing the right lens is critical. Think about what you'll be using the lens for. Do you need the ability to quickly change focal length? If so, a zoom lens will be better than a prime lens. Do you often work in low light conditions where a large

aperture will come in handy? If so, you'll need a lens with a larger aperture. Do you like photographing landscapes more, or people? These points will help you determine which lens will be best suited for what you want to photograph.

lenses, on the other hand, provide a variety of focal lengths in one lens. This makes them very versatile and also reduces the need for multiple lenses. Within these two groups, lenses come in a variety of focal lengths, from

fish-eye to super telephoto. The focal length is one of the key characteristics of a lens as it determines the angle of view as well as the magnification.

UNDERSTAND YOUR LENS



Looking at a lens, there is a variety of numbers, letters and symbols that may look quite confusing at first. These all indicate valuable information about the lens, such as focal length, maximum aperture, lens version and focusing motor. Other features specified include stabilisation and filter diameter (this is usually found on the front of the lens and indicated by the symbol \emptyset).

MACRO LENSES

Macro photography is extreme-close up photography, usually of small objects. It typically involves macro lenses, designed for photographing small subjects at very close distances – they have lower minimum focus distances and 1:1 magnification (meaning that the size of the image in real life is the same size as it's reproduced on the sensor). Macro lenses can also be used for other types of photography.



FOCAL LENGTH AND FIELD OF VIEW

Focal length is one of the defining characteristics of a lens, determining the angle of view as well as the magnification. When light enters a lens, glass elements within the lens converge the light to a single point, known as 'focus'. The focal length is determined by the position of this focus point in relation to certain lens elements. This is usually indicated on the side of the lens barrel and sometimes on the front of the lens, along with the lens diameter. Ranging anywhere from 8mm to 2000mm, there is a wide variety of focal lengths to choose from, each of which are better suited to different genres of photography. Lenses with shorter focal lengths provide a much wider angle of

view and are better suited to landscapes than product photography, for example. The opposite is also true for longer focal lengths, which may be better suited to sport or wildlife photography than architectural photography. Lenses with shorter focal lengths also provide less magnification than those with larger focal lengths. This is illustrated in the image below and explained in the video in this chapter, where you can also see examples shot using different focal length lenses for comparison.

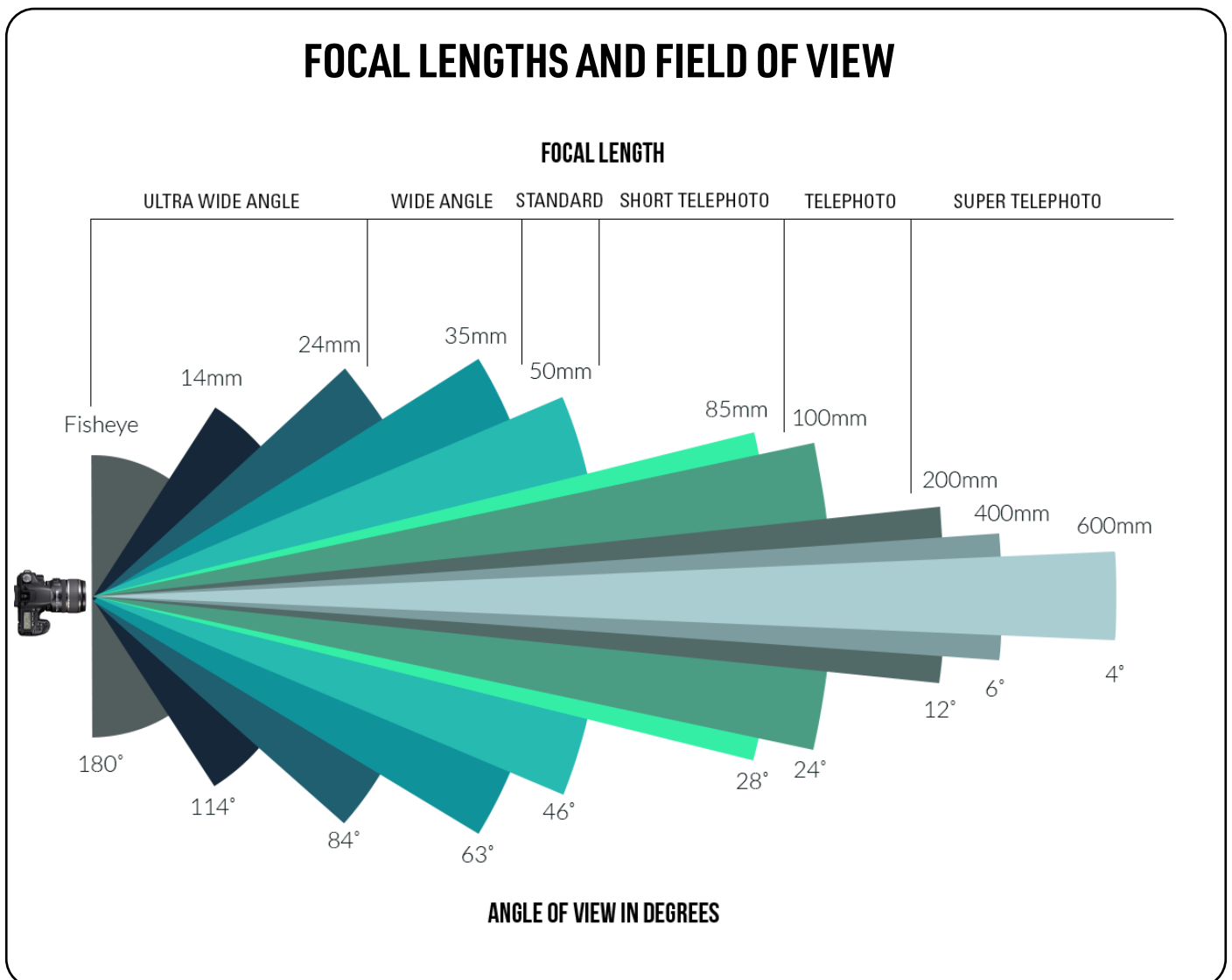

LENSES AND APERTURE

Although not specifically a type of lens, aperture is another important feature of lenses. As you learned in previous chapters, aperture refers to the opening in the lens that controls how much light reaches the sensor. This is indicated in the format 1:2.8, for example, with the second set of numbers indicating the maximum aperture. Some lenses will feature two maximum apertures (shown as 1:4-5.6). What this means is that, as you zoom, the aperture capability changes. So at the shortest focal length, you may be able to shoot at $f4$, but once you zoom to the longest focal length, the widest aperture you'll be able to shoot at will be $f5.6$. Generally, lenses with wider apertures are favourable due to their increased light-capturing capabilities. There is also a category of lenses that feature a fixed aperture.

Catadioptric, or mirror lenses, which used to be fairly common and are found in many telescopes, usually feature a longer focal length, such as 500mm at a fixed aperture of $f6.3$.



SUMMARY OF LENSES

FISHEYE LENS

Fisheye lenses produce a unique perspective due to an ultra-wide 180-degree field of view. Most notably, they produce strong distortion and a large depth of field. These lenses are usually only used when a very wide angle of view is required.

SUPER WIDE-ANGLE LENS

While a super wide-angle lens also offers a very wide angle of view, it does not cause distortion like fisheye lenses do. This lens also offers greater depth of field than larger focal length lenses.



WIDE-ANGLE LENS

Wide-angle lenses have greater focal distances compared to fisheye and ultra-wide angle lenses, but not as great as standard and other lenses. They are commonly used by landscape and architectural photographers.



STANDARD LENS

A standard lens offers a standard focal length and a standard field of view. These are good lenses to start with as they offer great versatility and can be used for a variety of different types of photography.



SHORT TELEPHOTO LENS

Short telephoto lenses offer larger focal lengths and allow you to photograph objects that are slightly further away. Their field of view is smaller than that of the lenses above.



SUPER TELEPHOTO LENS

Super telephoto lenses offer extremely long focal lengths and are typically associated with wildlife or sports photography, where it is not always possible to get close to the subject. However, they have a very limited field of view.



7. OPTICS AND LENSES

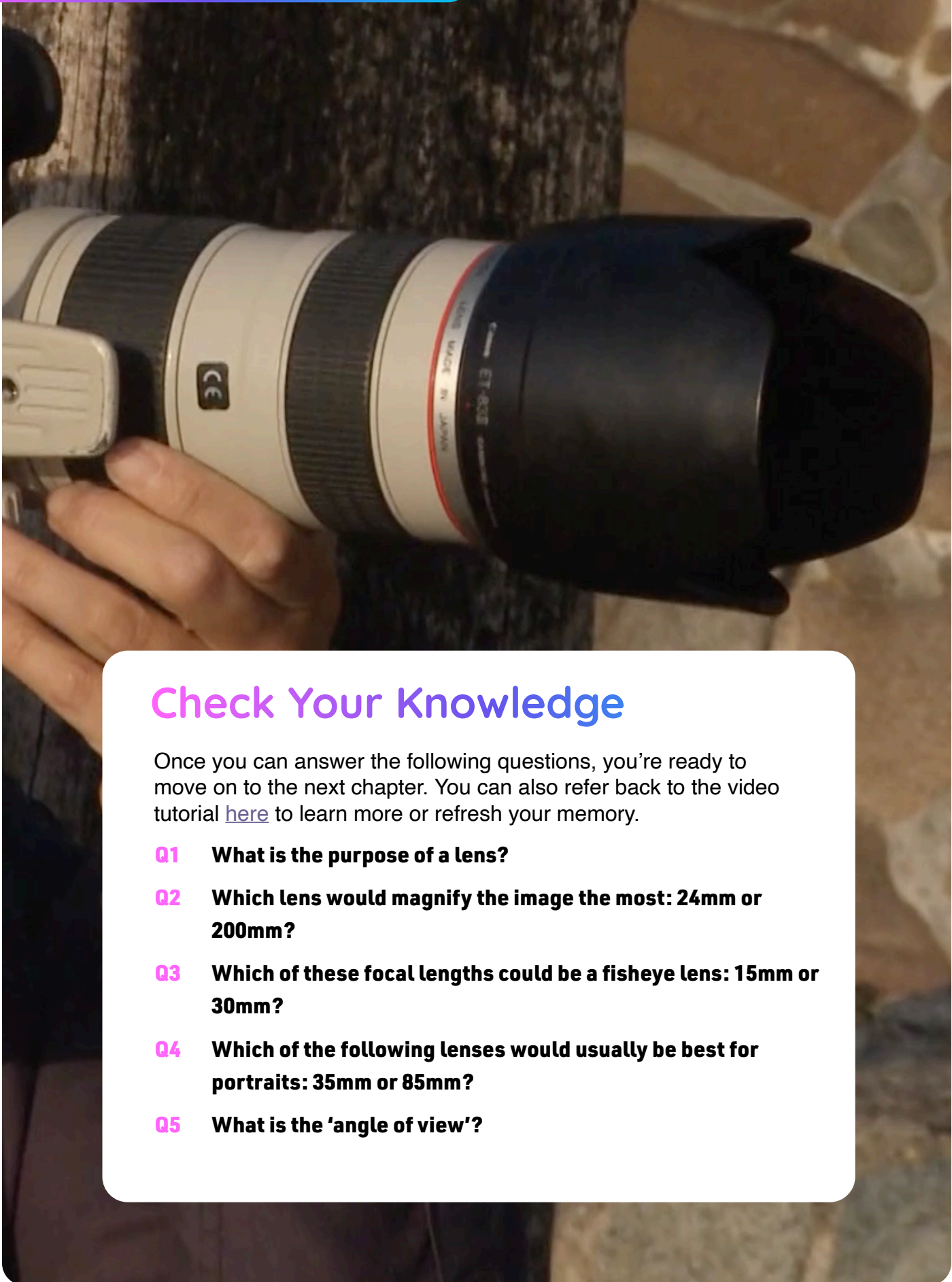

Check Your Knowledge

Once you can answer the following questions, you're ready to move on to the next chapter. You can also refer back to the video tutorial [here](#) to learn more or refresh your memory.

- Q1** What is the purpose of a lens?
- Q2** Which lens would magnify the image the most: 24mm or 200mm?
- Q3** Which of these focal lengths could be a fisheye lens: 15mm or 30mm?
- Q4** Which of the following lenses would usually be best for portraits: 35mm or 85mm?
- Q5** What is the 'angle of view'?

A young man and woman are walking hand-in-hand through tall, golden grass. They are both wearing white button-down shirts and light-colored shorts. The man is on the left, looking down at the woman's hand, and the woman is on the right, smiling. The background is a soft-focus landscape with a body of water and a clear sky. A white rounded rectangle is in the top left corner. A purple and blue gradient bar with a play button icon is at the bottom left.

“

**I WAS ALWAYS
FASCINATED BY
LENSES AND OPTICS
WHEN I WAS A KID,
AND TO BE HONEST
I STILL AM. I WAS
ALWAYS AMAZED
AT HOW LENSES
COULD MAGNIFY
THINGS THAT WERE
FAR AWAY AND
BRING THEM RIGHT
UP INTO VIEW. ”**





8

CHAPTER

UNDERSTANDING LIGHT



An Introduction to the Six Essentials of Photography
Light • Subject • Optics • Aperture • Time • Recording Medium

UNDERSTANDING LIGHT

TYPES OF LIGHT

Light is everything to a photographer, so pay attention to it in the world around you – and in other photographer’s images. Once you learn to appreciate and understand light, you will have a far better idea of how to use it to achieve creative results. In this

chapter, you’ll find explanations and examples of common lighting terms, simple combinations of light, colour temperature, white balance and the Kelvin scale. You’ll also see examples of how to combine light to achieve interesting creative results.

HARD LIGHT

Hard light comes from a small, or ‘point’, light source. The sun on a clear day is a perfect example. This may seem confusing at first, as the sun is obviously very large up close! But in photography, the size of the light source is defined relative to the subject. The distance of the sun therefore makes it small in relation to the subject.

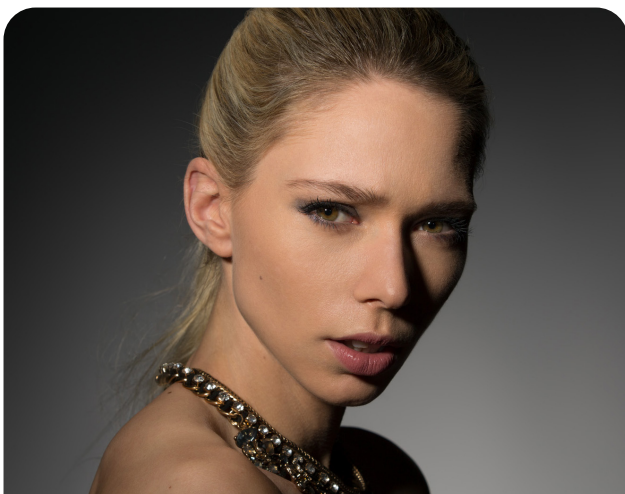

Discover this Two-Light Harsh Lighting

SOFT LIGHT

Soft light is the opposite of hard light and is produced by any light source that is very large from the subject’s perspective. This results in even light with little to no shadows. An example of soft lighting would be the sky on a cloudy day as the clouds act to diffuse the sun, turning it into a very large light source.



Discover this : Soft Side Lighting and Fill

NATURAL LIGHT

Natural light refers to any light emitted from the sun and is an essential tool for many photographers. Best of all, it's free and all around us! For the most pleasing natural light, photographers typically prefer to shoot in what is called the 'magic hour', shortly before and after sunset or sunrise.



Discover this : Natural-Light Portraiture

AMBIENT LIGHT

Ambient light refers to any light that is already present in a scene. This is also commonly known as 'general lighting' and could be anything from light from street lamps to light reflected off of a building or sunlight entering a room.



Discover this : Office Space Portrait

REFLECTED LIGHT

Reflected light occurs when light reflects off the surface of an object. Variations in the surface and texture of objects causes light to reflect differently. For example, light will reflect more evenly off a mirror compared to sand. Very few objects completely absorb light, which means almost all of the photos we take capture reflected light.



Discover this : Get Creative in Manual

TRANSMITTED LIGHT

Transmitted light is light that you can see emitted from its source. This means that we can see the light source directly in the picture. Examples of this could be candlelight or even the sun. It is also light that has passed through something before reaching the subject. This could be glass, water or even Earth's atmosphere.



Discover this : Sunset Seascape

COLOUR TEMPERATURE

To understand colour temperature, let's first look at light and the colour of light. Light consists of three primary colours: red, green and blue. Light in these colours can be added together to make secondary colours or, if all three primary colours are combined, white light. Different light sources will all have their own colour temperature. Candlelight, for example,

is a warmer colour with more red and orange tones than the cool, bluer light seen on a cloudy day. This light is registered by our eyes and by our cameras, but the way these two systems perceive light is different. Why do the scenes we see in front of us often look very different to what we capture with our camera? When we see a white object (like paper) in

THE KELVIN SCALE

Colour temperature is measured according to the Kelvin scale. In photography, this scale ranges from 1000K to 10000K, with 1000K being the warmest tones and 10000K being the coolest. For example, if you were sat in a room lit by candlelight, the colour temperature would be around 1500K. If you were sat in the sun on a clear, sunny day, the

colour temperature would be around 5600K. The Kelvin scale can be used to fix incorrect colour cast manually by selecting the current / matching colour temperature. To neutralise candlelight, it would therefore be necessary to adjust the Kelvin value to the same approximate temperature as the light source to make the image more neutral.

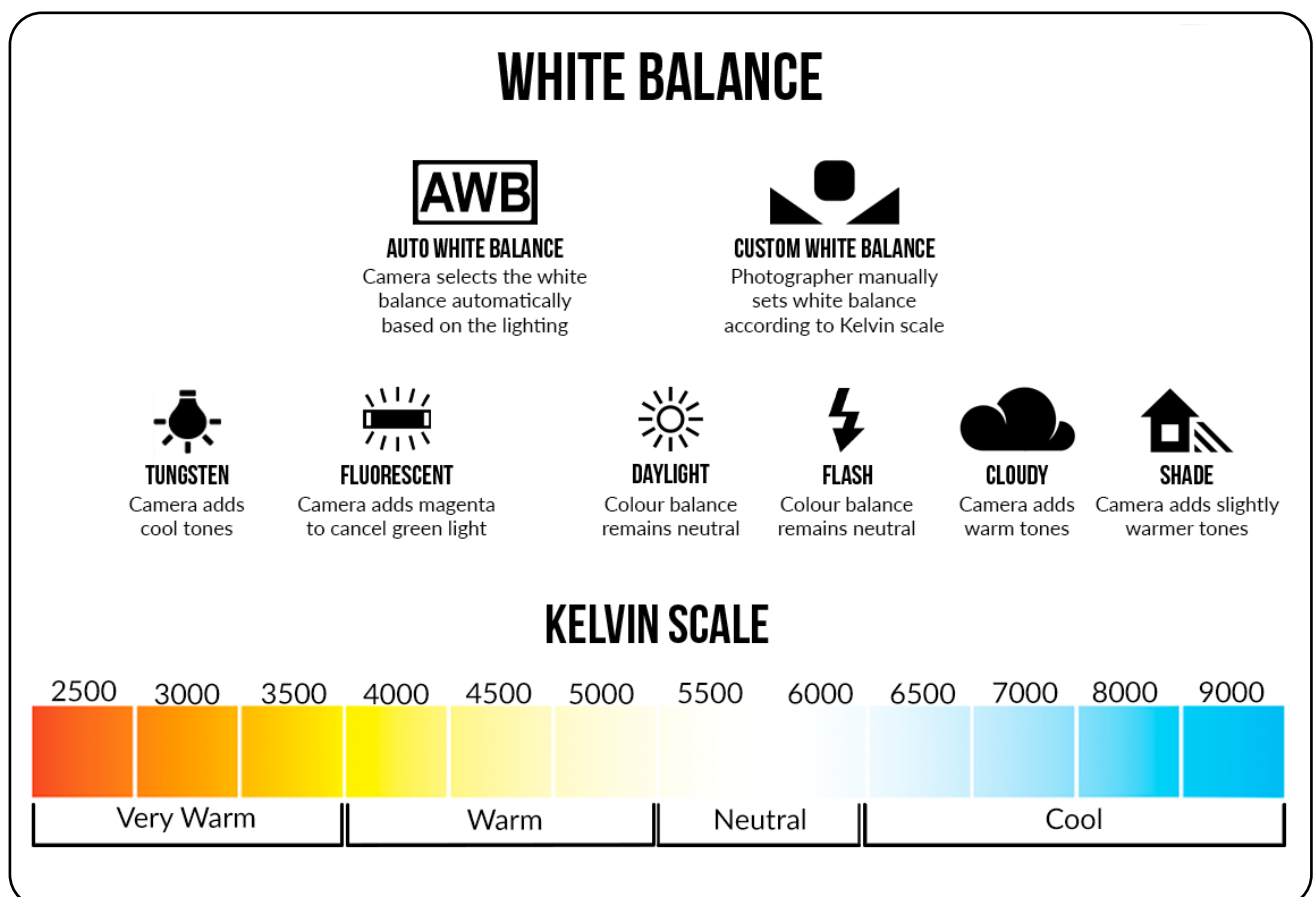

tungsten lighting, it looks white; the same way a white t-shirt in shade also looks white. This is because our brains automatically correct it for us. The Auto White Balance function on our cameras does something similar. As photographers, we can use this feature to correct the colour temperature. We can also use other white balance settings or the Kelvin

scale. White balance refers to the process of correcting inaccurate colour cast caused by different light sources. Most cameras feature Tungsten, Fluorescent, Daylight, Flash, Cloudy, Shade or Custom White Balance settings, each of which will apply the appropriate colour correction to the image, based on the colour temperature of the scene.

CORRECT WHITE BALANCE

Using the right white balance settings on your camera can have a big impact on the final shot. Here we can see that using the appropriate white balance setting (in this case Tungsten) results in a far more natural-looking image. This is because the Tungsten setting has shifted the Kelvin scale to compensate. This corrects the colour, cancelling out the overly orange tones in the image to the right.



INCORRECT WHITE BALANCE

This image appears much warmer, with a much more orange tone. This is due to incorrect colour balance. In this case, using the Daylight white balance setting did not correct the warm colour cast from the tungsten lighting, resulting in a strong orange tint.

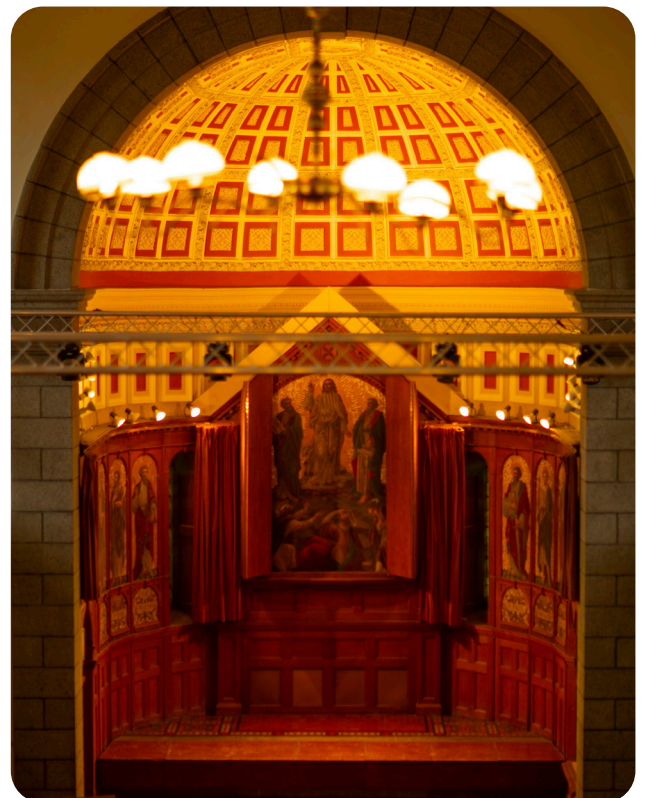

COMBINING LIGHT

In this section, we're going to look at different two-light combinations. But it is important to keep in mind that many images, including some of the examples below, will actually feature more than two types of light. It is good

practice as a photographer to try and identify the types of light, as well as the direction of the light, in any photographs you look at. This will help you understand how light works, how it interacts with different surfaces and

COMBINATION: HARD AND SOFT LIGHT

When we combine hard light and soft light, the result is dynamic lighting that has a little less contrast than a photograph featuring exclusively hard light. This is because the image contains harsher shadows and/or strong highlights from the hard light along with areas of softness from the soft light. In this image, we can identify the hard lighting on both sides of the model, in the form of rim lighting with strong highlights. The soft lighting is hitting the model from the front, casting soft shadows and softer highlights.



Discover this : High-Key Fashion

COMBINATION: TRANSMITTED AND REFLECTED LIGHT

In this image, the transmitted light (a light source that is visible in the image and has travelled through an object) is the setting sun that is visible shining through the glass of the Louvre. The image also features reflected light (light that reflects off the surface of an object). This is clearest on the floor of the structure. Here we see the sun reflecting in the shiny surface of the floor. There is also light reflecting off the floor between the camera and the structure.

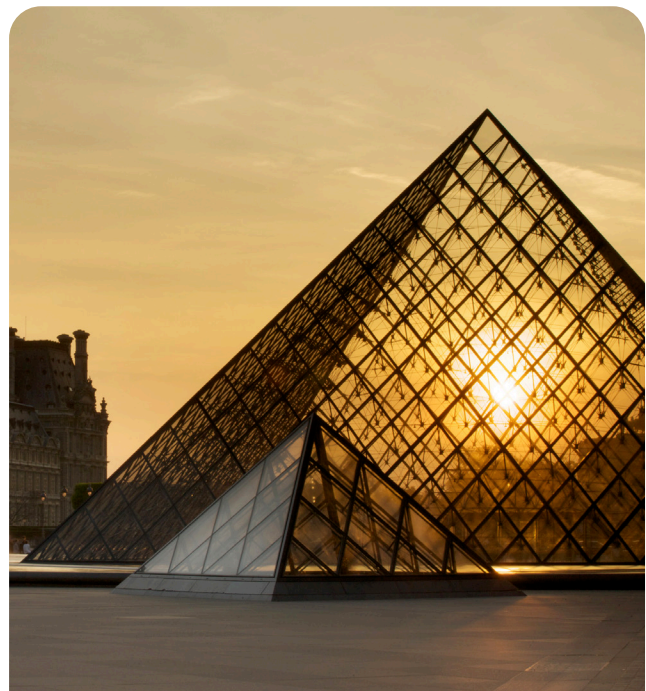

Discover this : Sunset Photography

mixes with different types of light. When you can recognise and understand different types of light, you will be far better at using it effectively in your own photography.

COMBINATION: NATURAL LIGHT AND ARTIFICIAL LIGHT

This combination can produce some interesting creative effects, as you can see here. In this example, the subject is clearly lit from the front while also being backlit by the sun. Backlighting can be a creative way to use natural light, but it does require extra light to achieve the right exposure. Karl achieved a good balance in this image by also using artificial light – specifically, speedlights. Without this extra artificial light, the subject would have been silhouetted.



Discover this : Speedlight Fashion Shoot

CHAPTER SUMMARY

The importance of light in photography cannot be overstated. We use it to create images, and to establish the mood and feel of an image in order to impact the viewer's emotions. Once you understand light, you will have the key to photography. In this chapter, you have seen examples of different types of light (including hard light, soft light, transmitted light and reflected light) and how they can be used to evoke certain emotions. The 'magic hour' is usually the best time of day to photograph as it produces a mixture of hard and soft

light. You also looked at how we can control light to get the best results, be it using accessories such as reflectors, or even studio lights. The colour of the light and the colour temperature also have an impact on the mood and feel of an image and we can control this using the different white balance settings on the camera and by understanding the Kelvin scale.

8. UNDERSTANDING LIGHT



Check Your Knowledge

Once you can answer the following questions, you're ready to move on to the next chapter.

- Q1** What does 'hard light' and 'soft light' mean?
- Q2** What different results would you get if you used hard light or soft light?
- Q3** Where does light come from?
- Q4** What natural weather conditions give us 'soft light'?
- Q5** What is colour temperature?
- Q6** What units are used to measure colour temperature?



“

LIGHT IS THE
MAGICAL STUFF
THAT WE USE
TO CREATE
OUR PICTURES.
WITHOUT LIGHT,
PHOTOGRAPHY
WOULD BE
IMPOSSIBLE.

”





9

CHAPTER

THE RECORDING MEDIUM

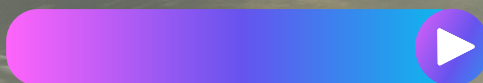

An Introduction to the Six Essentials of Photography
Light • Subject • Optics • Aperture • Time • Recording Medium

RECORDING MEDIUM



WHAT IS THE RECORDING MEDIUM?

The recording medium is what is used to record an image. Once the light has passed through the optics of the camera, the aperture and shutter, an image is recorded. In a film camera, the image is recorded via a chemical reaction triggered by the light hitting the photographic film. In a digital camera, that film is replaced by a sensor. There are two different types of sensor: CMOS and CCD. These sensors come in a variety of sizes: crop-sensor, full-frame and medium format. These were mentioned briefly in Chapter 1 and are further explained

later in this chapter. All sensors function in the same way. An image is created from millions of pixels (tiny dots of colour, essentially recorded by an array of millions of tiny light sensitive photosites on the camera's sensor. During the exposure, photons (the fundamental particles of light) strike these photosites. This interaction is recorded as an electrical signal, which is then recorded in a binary format that describes the image.

THE CAMERA OBSCURA

The camera obscura ("dark chamber" in Latin) was used in the 16th century as a visual aid for artists. The light enters the dark space through a tiny hole and is projected as an inverted image onto the back wall of the camera obscura. By the 19th century, it became possible to record the projected image using photosensitive materials, such as film. In the most simplistic terms, similar mechanics are replicated today in digital cameras. The small hole has been replaced by the aperture and the

back wall of the camera obscura has been replaced by the camera sensor.

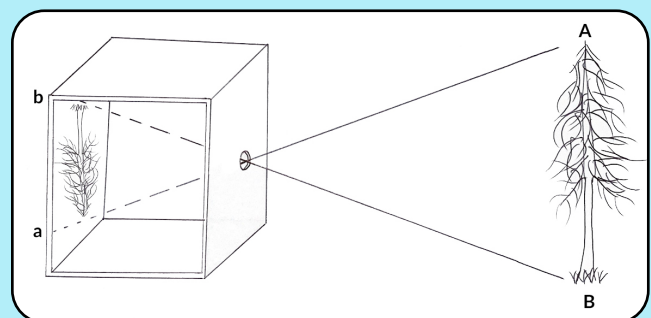

TYPES OF RECORDING MEDIUM

The two main types of sensor are CCD (Charge-Coupled Device) and CMOS (Complementary Metal-Oxide Semiconductor). Until recently, CCD sensors were the most common sensor thanks to their excellent image quality, dynamic range

and noise control. However, as technology has progressed, CMOS sensors have now taken over. Generally speaking, larger sensors offer the highest quality while smaller sensors provide a more economic option while still delivering great results.

FILM

Digital camera sensors are not the only way to record an image: film cameras remain an option to photographers today. Just as sensor size varies, so does film size, from 35mm (which is what today's 35mm digital cameras were based on) to larger 6x4.5 medium format and even 10x8 large format film.



CAMERA SENSORS

Camera sensors also come in different sizes (also referred to as 'formats'), with smaller sensor sizes generally offering lower image quality compared to that of larger sensors.

The three main sensor formats are medium-format, full-frame, and crop.

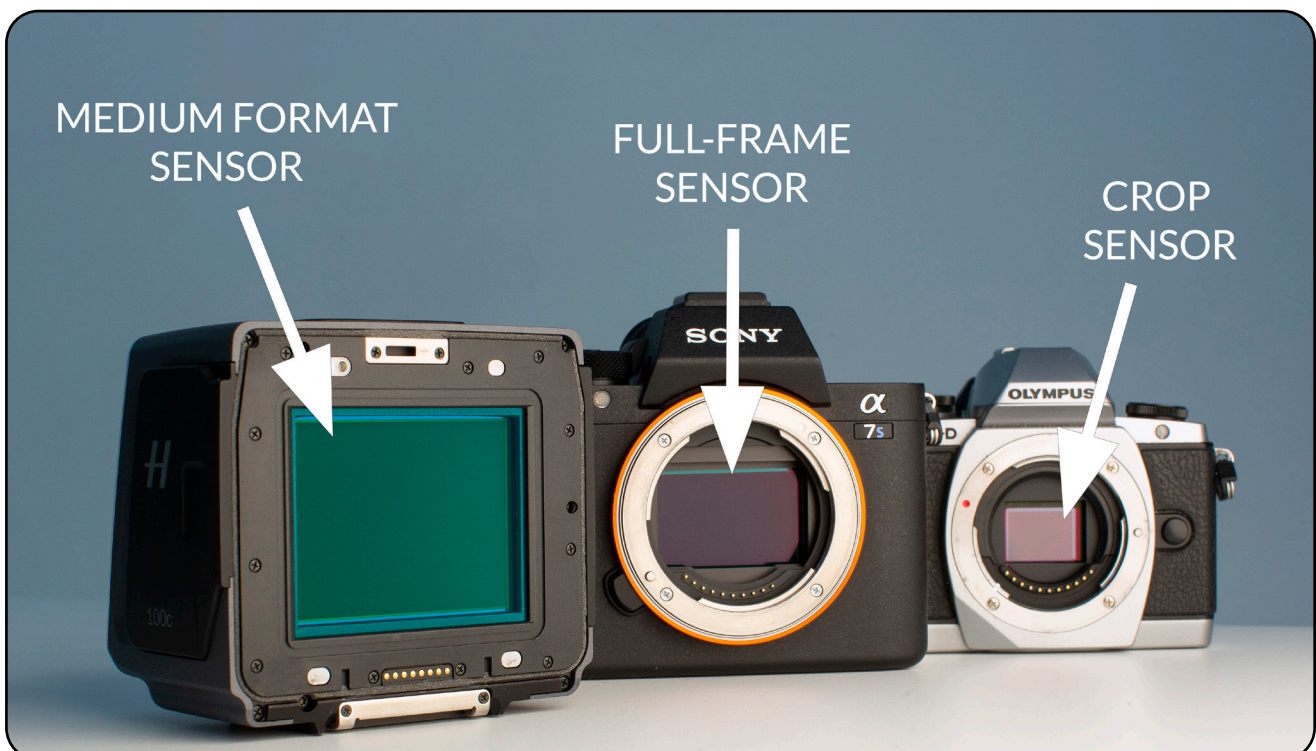

Image quality is partly determined by factors such as sensor type (and size), resolution (number of megapixels) and ISO. In this chapter, we look at a number of comparisons to illustrate how these factors influence image quality, as well as

the differences between sensor sizes, the megapixel capabilities of various cameras, the variations in ISO settings and JPEG and RAW file types.

SENSOR SIZES

Crop sensor cameras, also referred to as APS-C, feature the smallest sensor sizes: approximately 23.5mm x 15.6mm compared to the 36mm x 24mm full-frame sensor. This makes them smaller, lighter and typically more affordable than their full-frame counterparts. Full-frame cameras, because of their larger sensor size, are bigger and generally offer better image quality and enhanced performance in low light

conditions. Medium-format cameras offer the largest sensor: 53.4mm x 40mm. This allows for much higher resolution as well as greater tonal range and colour accuracy. Mostly used by professionals, this type of camera typically comes with a much higher price tag than crop-sensor or full-frame cameras.

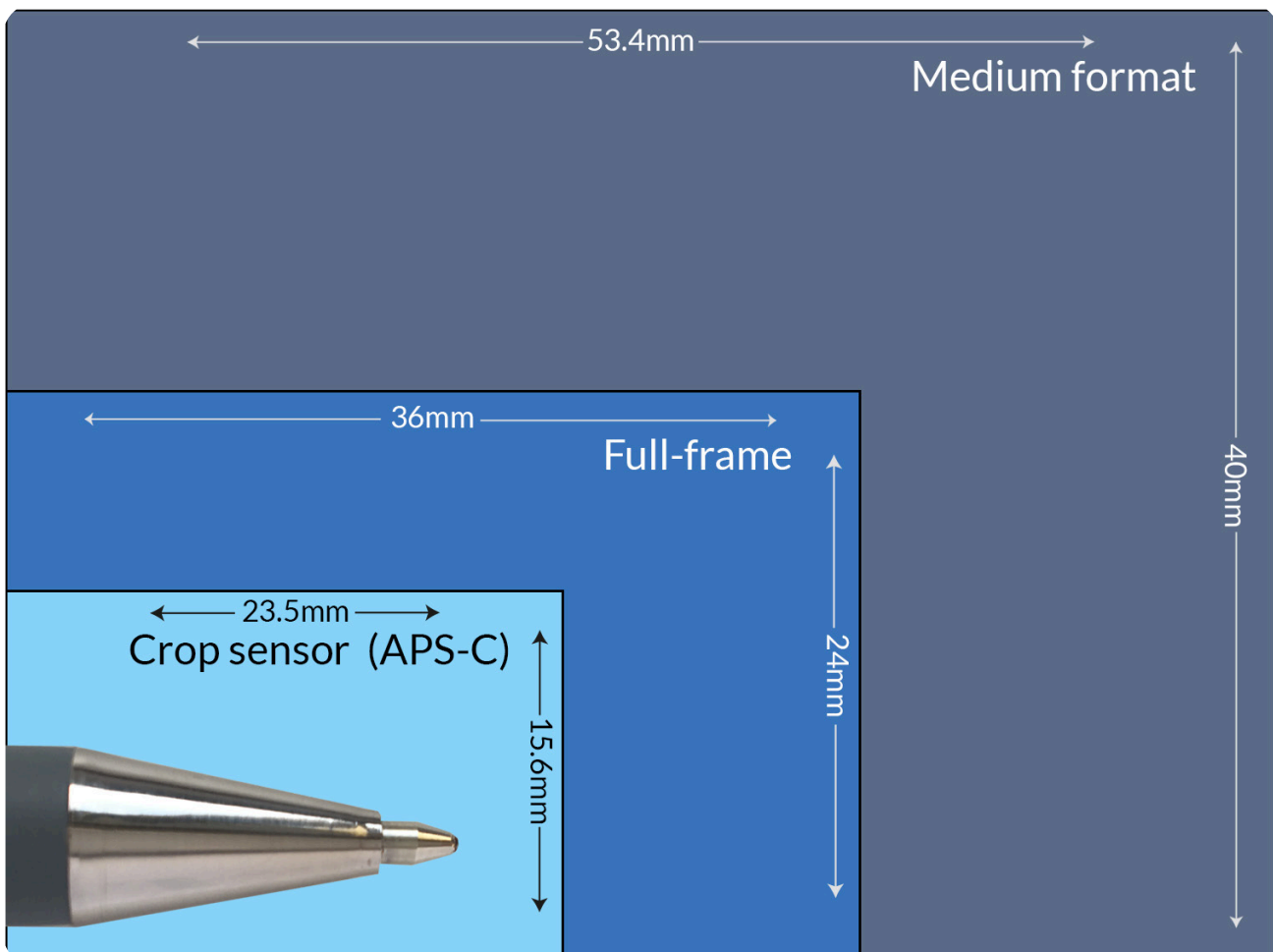

MEGAPIXELS AND RESOLUTION

'Megapixels' and 'resolution' refer to two very different things, and it is important to understand the difference. The number of megapixels varies from camera to camera, which results in varying pixel size and image quality. Resolution, on the other hand, refers to the camera's ability

to capture and record detail in images. Although it is related to the number of megapixels, resolution is not solely dependent on this, but rather on how well the camera and the lens can resolve detail.

PIXELS

One megapixel is made up of a million pixels, which means that a 24-megapixel camera will record an image that is made up of 24 million pixels, while a 16-megapixel camera will record an image with only 16 million pixels. Each of these individual pixels contains information that makes up the final image. When determining image quality, it's not only the number of megapixels that matters, but also the size of the photosites that record pixels. Photosites are measured

in microns (μm), and their size is largely determined by the sensor size. Cameras with smaller photosites may perform worse in low light conditions and also suffer from more diffraction when you're shooting at small apertures. Larger photosites allow for a larger transitional tonal value, greater tonal accuracy and better colour accuracy. You can see a comparison of images taken on a 12-, 22- and 100-megapixel cameras in the video.



COMPARING 12-, 22- AND 100-MEGAPIXEL CAMERAS

Different cameras have different numbers of megapixels. Depending on the size of the sensor and the number of megapixels, the size of the pixels can vary. This dictates the level of detail captured in an image. To demonstrate this, the Chapter 9 video shows a comparison between 12-, 22- and 100-megapixel cameras. Shot using the same settings, the results initially all look very similar. But closer inspection reveals

the differences. Having zoomed in to closely inspect each image, the differences were much more obvious and the variations in the level of detail were immediately clear. These are clearly shown and discussed in the video chapter.



RESOLUTION

Resolution does not only refer to the number of pixels within an image. Rather, it refers to how clearly the medium can capture and record detail. This is determined by the sensor type and quality of the lens. Although megapixels relate to resolution, they are not the defining characteristic. This means that while images with more megapixels will generally have a higher resolution, images with the same number of megapixels can have different resolutions. By simply using

two different versions of the same lens on the same camera, we could change the resolution. For example, an image shot with an older lens will have a lower resolution than the same image shot with a newer model lens with better optical design. The same number of megapixels will be recorded (because it's the same camera), but the newer lens will produce better contrast, colour fidelity and overall sharpness.

ISO

ISO measures how sensitive the recording medium is to light. By adjusting the ISO, we can make our cameras more or less sensitive to light. Higher ISO means greater sensitivity, whereas lower ISO numbers will be less sensitive to light. While increased sensitivity

may sound good in theory, higher ISOs can result in degradation of image quality. This often takes the form of 'noise', especially in the shadow tones.

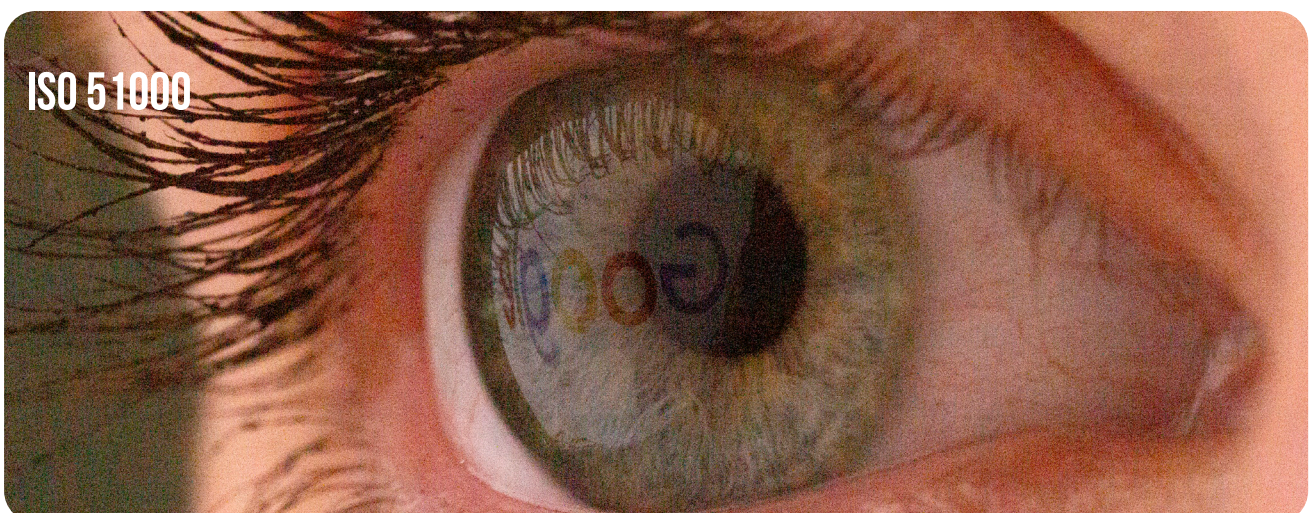

JPEG VS RAW

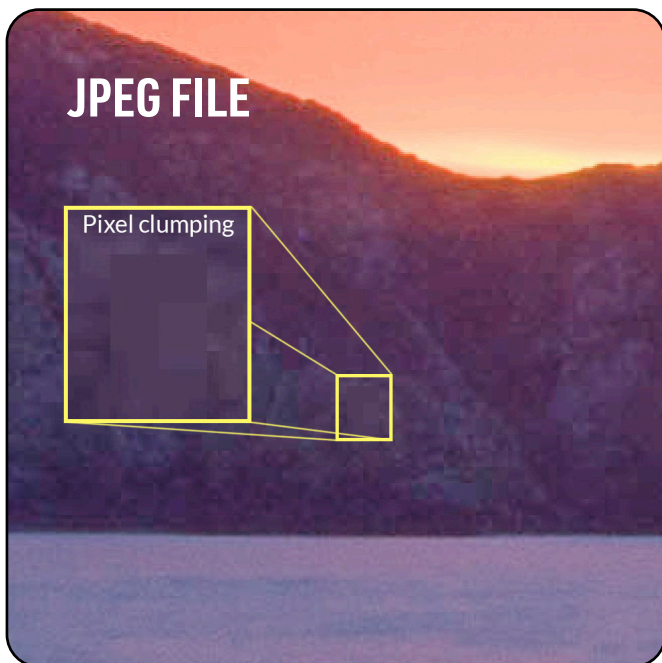

Another factor that relates to image quality is the type of file format you shoot in. This is most commonly either JPEG or RAW (some camera brands have their own file formats). Although both file types contain the same number of pixels, RAW images store far more information within those pixels than JPEG images do. This means that with a RAW image file we have far more control in the post-production stage, which can be very useful if you want to make changes to your pictures after shooting. Shooting in RAW is particularly beneficial if you need to adjust the colour (either the colour temperature or tint) in post-production. This is because, with RAW files, you have complete control over the colour. As explained in the video, one of the main drawbacks of JPEG files is that the file compression can sometimes result in what is known as 'pixel clumping'. This is when pixels of a similar tone are grouped together. Although this may not initially be apparent, it becomes more obvious when we start to adjust colours and exposure in post-production. In the images on the left, you can see instances of pixel clumping in the JPEG file, but not the RAW file.

Although JPEGs may not allow us to extract as much tonal information, especially in highlight or shadow areas, they are still a common file type for those shooting high volumes of images (such as wedding or sport photographers). This is because, due to their compression, JPEGs are smaller than RAW files.

CHAPTER SUMMARY

Sensors, megapixels, resolution, ISO and file type all contribute to image quality. But you don't have to shoot with the camera with the largest sensor, with the most megapixels and at the lowest ISO. Most of the cameras on the market today are of exceptionally high quality, far greater than those from the days of film

– and those film cameras produced some of the most iconic images of our time! If you have the right knowledge and expertise, you can create amazing quality images with any camera.

9. THE RECORDING MEDIUM

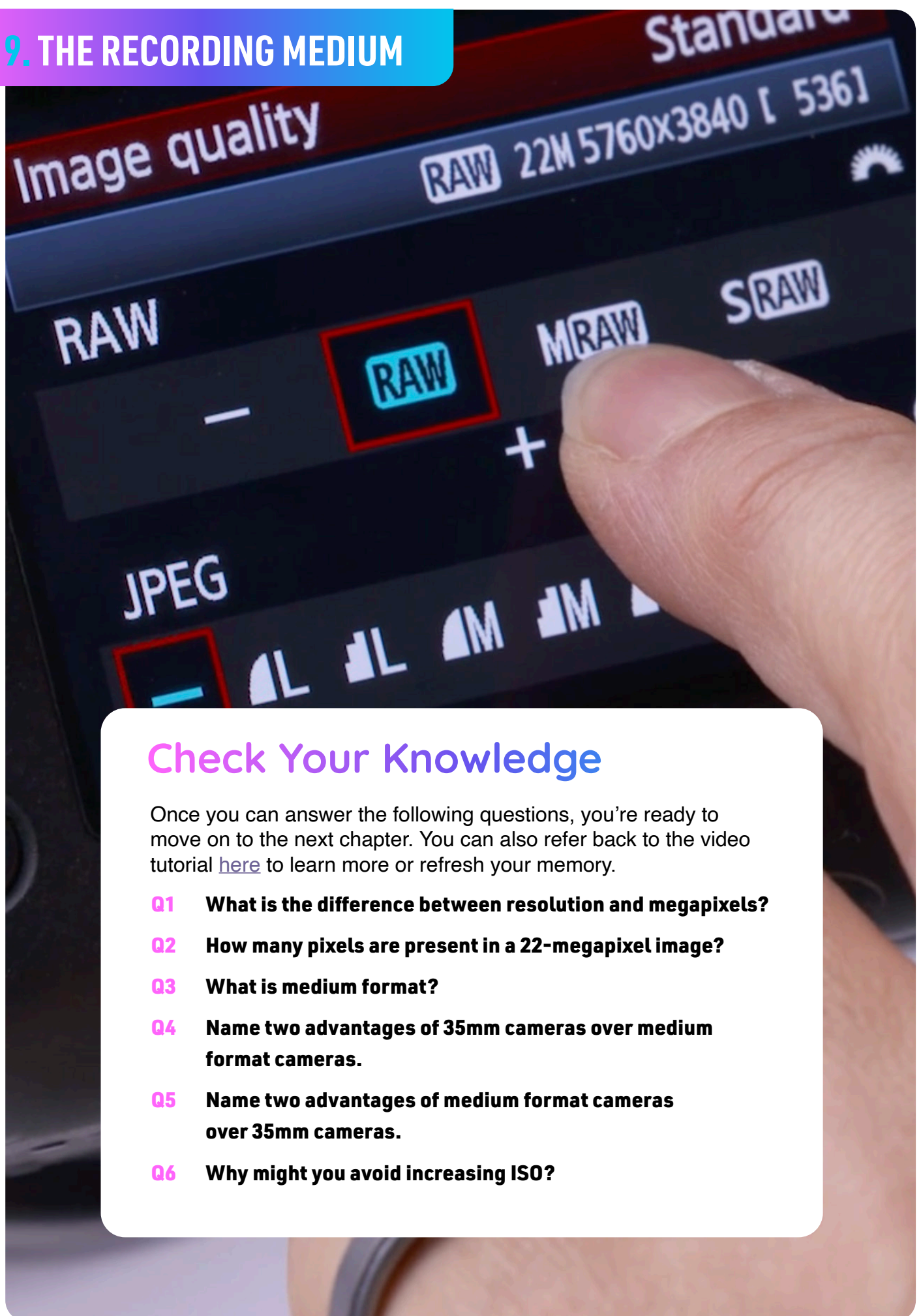

Check Your Knowledge

Once you can answer the following questions, you're ready to move on to the next chapter. You can also refer back to the video tutorial [here](#) to learn more or refresh your memory.

- Q1** What is the difference between resolution and megapixels?
- Q2** How many pixels are present in a 22-megapixel image?
- Q3** What is medium format?
- Q4** Name two advantages of 35mm cameras over medium format cameras.
- Q5** Name two advantages of medium format cameras over 35mm cameras.
- Q6** Why might you avoid increasing ISO?



“

**NEVER FORGET
THAT ALL
THE GREAT
PHOTOGRAPHS
IN HISTORY WERE
MADE WITH
MORE PRIMITIVE
CAMERA
EQUIPMENT THAN
YOU CURRENTLY
OWN.**

”



10

CHAPTER

COMPOSITION

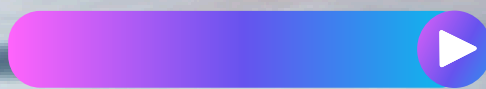

An Introduction to the Six Essentials of Photography
Light • Subject • Optics • Aperture • Time • Recording Medium

COMPOSITION



WHAT MAKES A GOOD COMPOSITION?

We know when we are looking at a well-composed image, but we may not always understand why. There are many elements that make up a strong composition and it can take years of study and practice to master the complexities, through a deeper understanding of human visual perception. Nevertheless, there are some simple guides that you can follow. Keep in mind, however, that composition guidelines are not hard and fast 'rules'. What works in one image may not

work in others. In this chapter, we'll explore some examples of effective composition and examine strategies like leading lines, framing and symmetry. We'll also look at the benefits of particular colour combinations, as well as common 'rules' of composition including the rule of thirds and the golden spiral.



GUIDELINES TO CONSIDER

The compositional guidelines explored in this chapter predate the practice of photography. They were initially explored in more detail by the French Impressionist painters of the 19th century. They experimented with compositional techniques such as

lines, shapes, tones and colours in order to lead the viewer's eye to the focal point of a painting. So how does this apply to photography? When you're capturing an image, it is important to identify what the subject of focus is. For example, in portrait

LEADING LINES

Leading lines are lines (or curves) that guide the viewer's eye to the subject. From fence posts to winding roads, leading lines can be straight, curved, diagonal or converging. These lines help keep our eye in the frame and draw attention to the subject.

Here are some examples of leading (see more in the video). In the top image the model, standing just off centre, is the focal point, with the long red dress blowing in the wind. Our eye is guided into the image from both the left, right and centre by different leading lines. The leading lines on the left and right are created by the edges of the road and the mountains in the background. The leading line in the center is created by the white, painted line down the middle of the road.

In the bottom image, the steps on which the model stands draw our eye towards the subject. Coming in from the left of the image, the lines guide you through it. (This relates to left-to-right bias, which links to the science of human visual perception). This image also makes use of other compositional elements, namely colour (colour theory is discussed more in the video in this chapter). This combination produces a dynamic image that immediately grabs and holds our attention.

Discover this class: Highlands Road Shoot

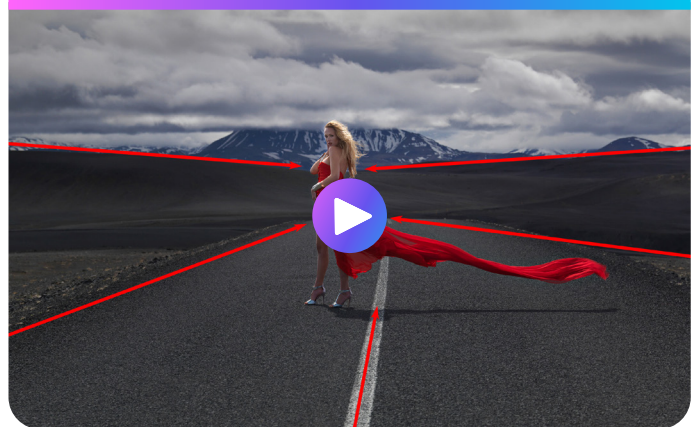

Discover this class: Simple Fashion on Location

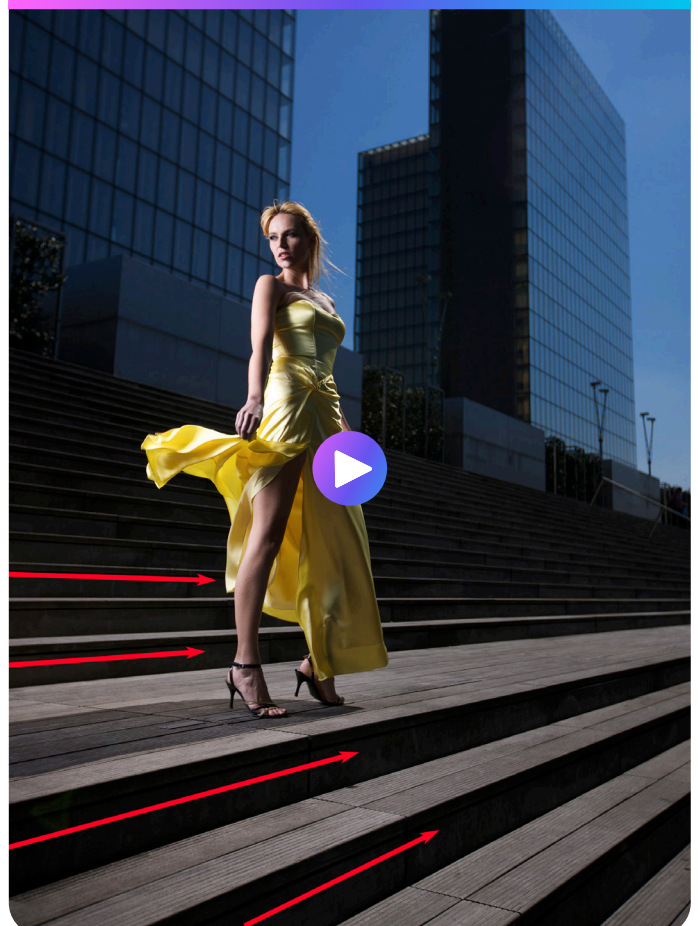

photography this is typically the eyes of the subject; in seascape photography it is typically the sun as it rises or sets; in architectural photography it is the building; in fashion photography it is the model and outfit; and in product photography it is the

product. As a photographer, it is your job to compose your shot in such a way that captures the viewer's attention and draws it to the main focus point, your subject.

FRAMING

Framing involves using other elements within the image to frame your subject. As shown below, examples of framing can be anything from the shape of the light, to a thoughtfully constructed backdrop. Framing can add additional elements of interest to your image. It can also add perspective and a sense of scale to your images.

SYMMETRY

Often associated with beauty, symmetry is all around us in nature. The line of symmetry splits an image in half either vertically or horizontally. If both sides of the line mirror each other, the image is symmetrical. Symmetry can be very effective when used correctly. Often quite striking, it can help remove or minimise additional distractions and focus the eye.

Discover this class: Fantasy Fatale Shoot

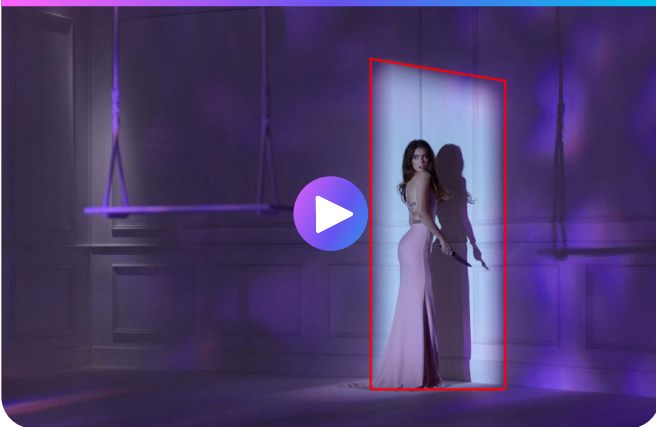

Discover this class: Moody Two-Light Control

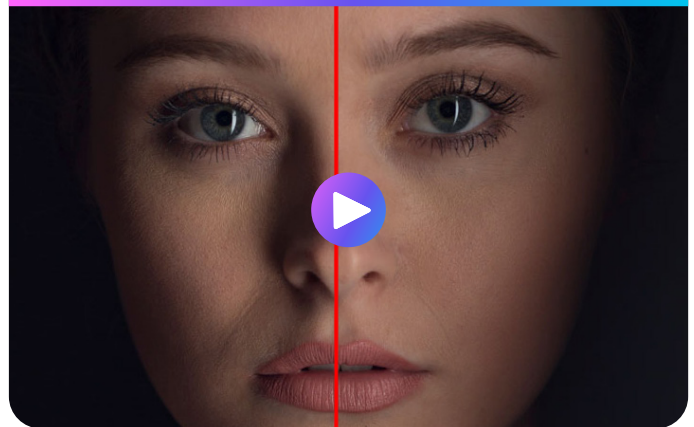

Discover this class: Perfume Advertising Shoot

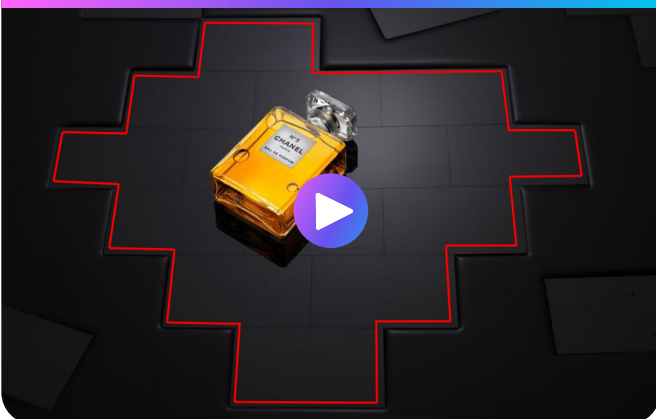

Discover this class: Paint Sports Shoot

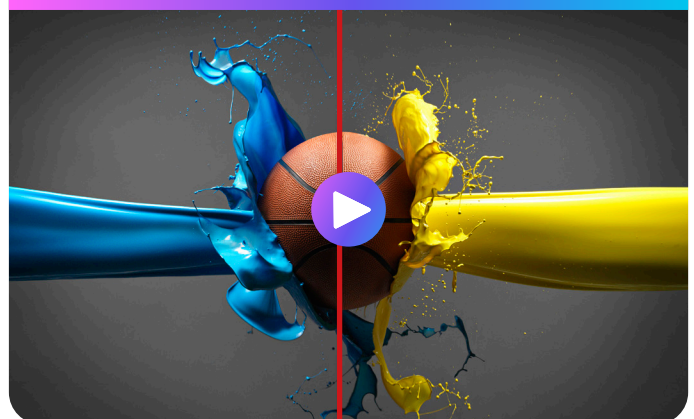

COLOUR

Colour is an important part of photography. We can use colours to change or influence the mood and feel of an image or to draw attention to particular elements. Juxtaposing colours (or other colour schemes) within an image can be a particularly effective way of catching the viewer's attention, as shown in the examples in the video.

Discover this class: Hasselblad H6 Shoot



Discover this class: Shooting Car Trails

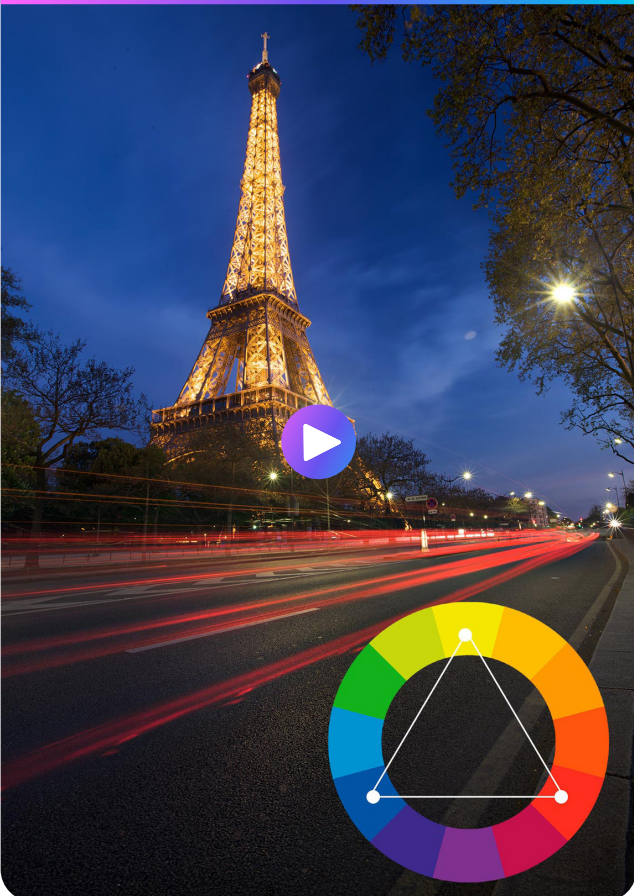

THE RULE OF THIRDS

One of the most well-known compositional rules, the rule of thirds divides the image into three rows of three, splitting the image into nine equal blocks. The idea is to position important elements so that they fall either on the dividing lines or at the points of intersection. Placing objects within these areas helps to create more interest in the image than if you were to simply centre the subject.

Discover this class: Coastal Sunset Shoot

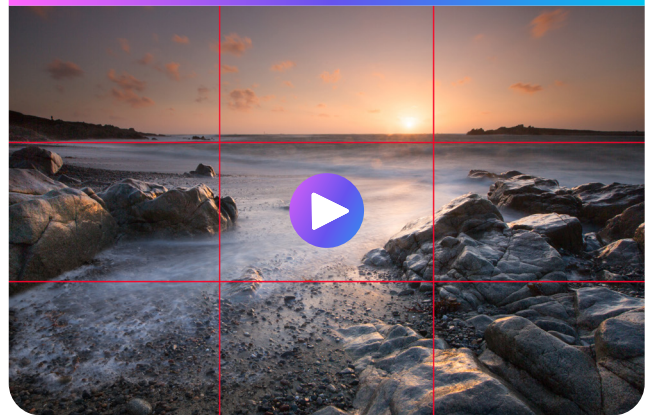

Discover this class: Star Trails Shoot

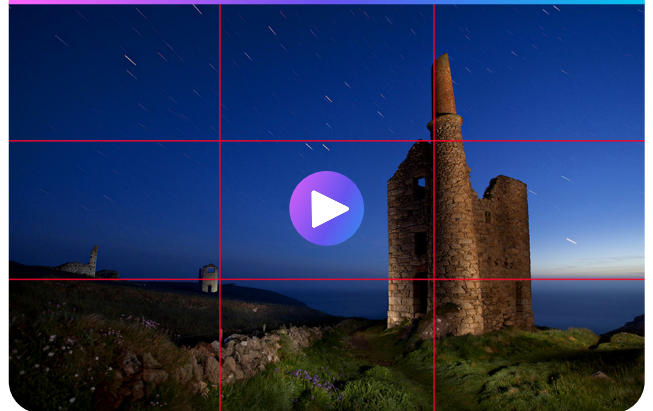

Discover this class: Lingerie Shoot

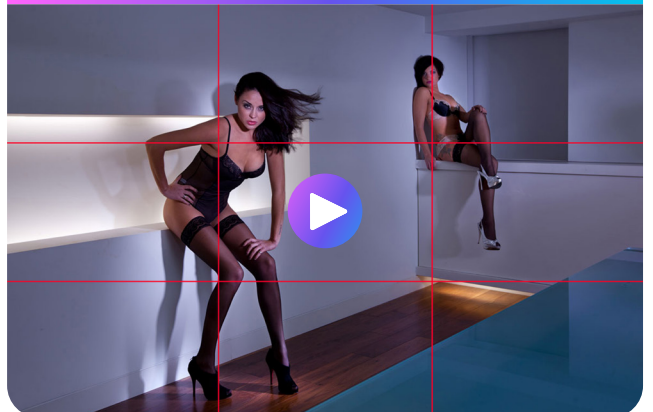

THE GOLDEN SPIRAL

The golden spiral rule derives from the golden ratio, a mathematical formula that relates to Phi (1.6180339...). Two quantities (a and b) fit the golden ratio if b is to a what a is to the sum of $a + b$. In this ratio, a is 1.6180339 times bigger than b . This formula forms the basis for other compositional rules, such as the golden spiral and to some extent the rule of thirds.

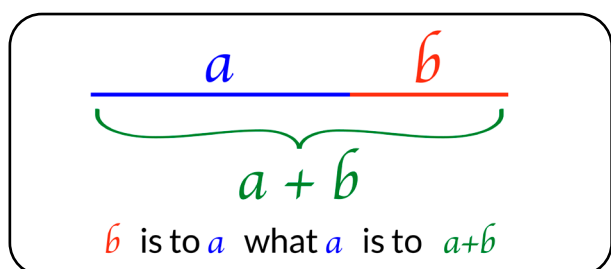

The golden spiral, developed by Fibonacci, is, contrary to its' name, composed out of a series of Phi Grids (formed using the principle outlined above). These grids determine the path of a snail-shaped spiral known as the Fibonacci Spiral, which guides your eye around the image to the focal point. You can see how this works in the image on the right.

While it can help to keep these compositional rules in mind when photographing, these 'rules' are not the be-all-and-end-all of composition in photography. The most important aim is

to maintain your viewer's attention and keep their eye in the frame. This can be done using other techniques that link to the human visual system. Understanding the science of human visual perception and concepts such as left-to-right bias, contrast, colour, narrative, etc. improves our ability to hold the viewer's attention with our images.

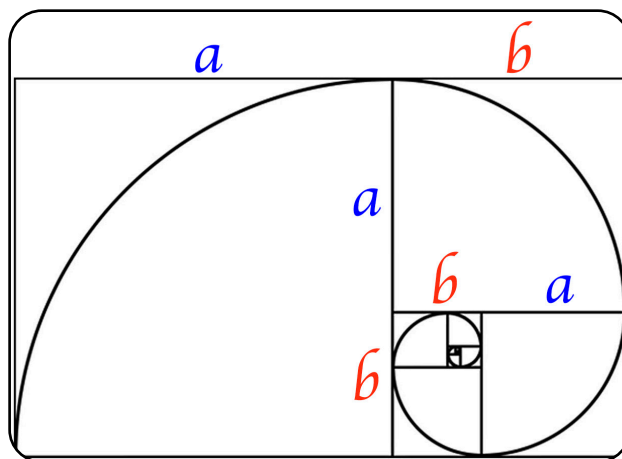

Discover this class: [Color Paint Sports Shoot](#)

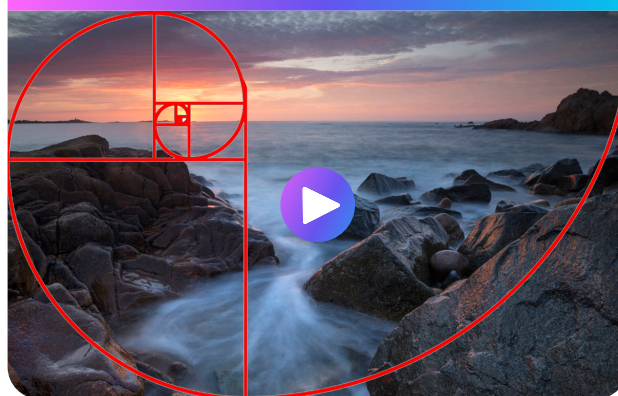

CHAPTER SUMMARY

As photographers, our goal is to keep the viewer connected with our image. While it can be beneficial to try and follow compositional guidelines, good photography comes down to far more than just composition-by-numbers. Many photographers fixate on composition, but there are other elements at work in strong, creative imagery. Use the rules and concepts discussed to guide you, but don't

take them as gospel. There is more to good imagery than the rule of thirds or golden spiral. It's therefore important to make sure you understand all the concepts covered in this course: how cameras work, how time and aperture can be used together for creative imagery, optics and their differences, the importance of light for conveying emotion, the subject and what you want to say with your photographs, and the different types of recording medium.

10. COMPOSITION

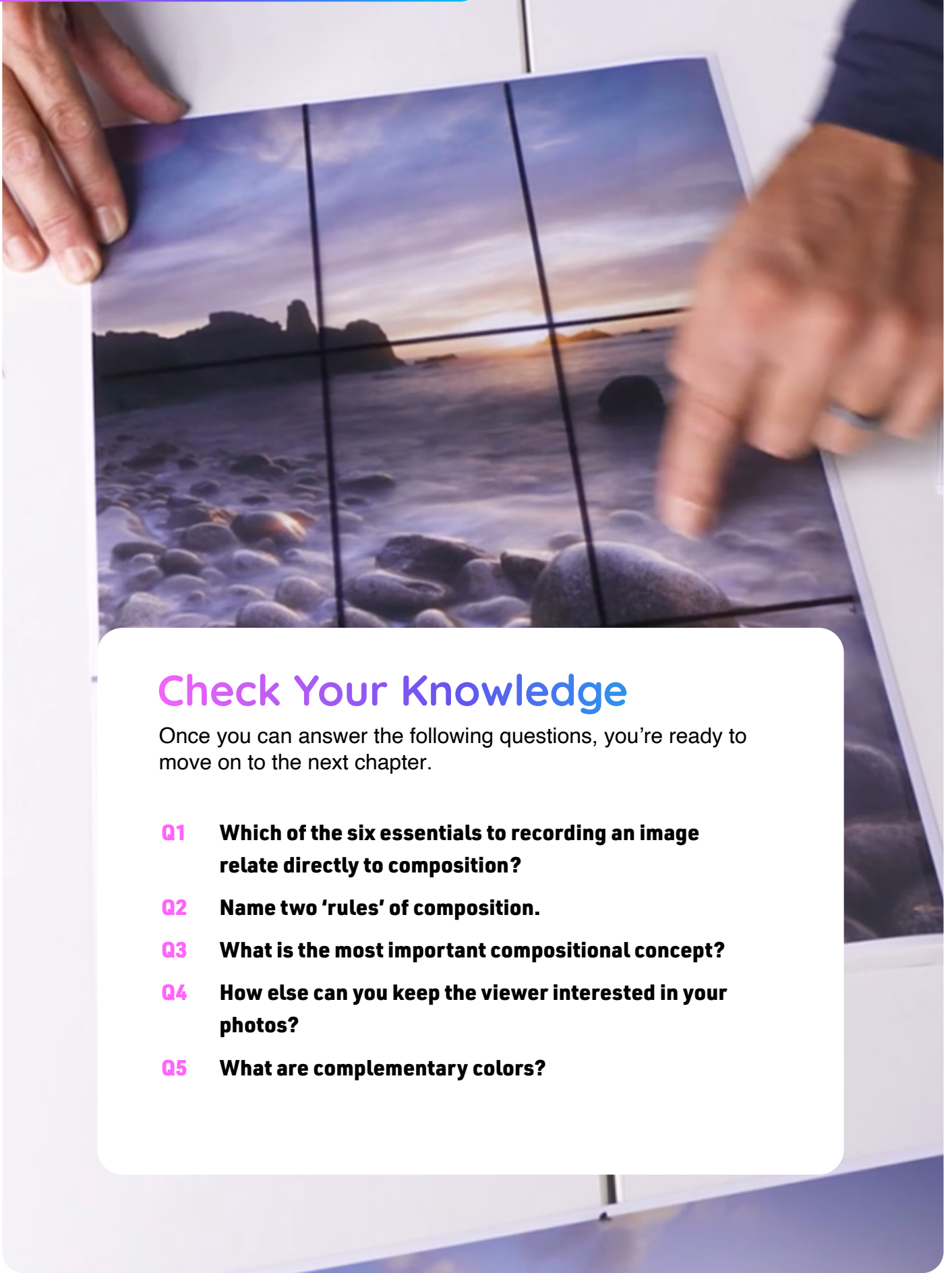

Check Your Knowledge

Once you can answer the following questions, you're ready to move on to the next chapter.

- Q1** Which of the six essentials to recording an image relate directly to composition?
- Q2** Name two 'rules' of composition.
- Q3** What is the most important compositional concept?
- Q4** How else can you keep the viewer interested in your photos?
- Q5** What are complementary colors?

“

THE MOST
IMPORTANT
OBJECTIVE IS TO
KEEP YOUR VIEWER
CONNECTED
THROUGH EMOTION,
ANTICIPATION,
CURIOSITY AND
NARRATIVE.
THESE ARE OFTEN
ELEMENTS I
DELIBERATELY
INCLUDE IN
MY WORK TO
FURTHER ENHANCE
THE VIEWER'S
EXPERIENCE. ”





11

CHAPTER

PRINTABLE INFOGRAPHICS

An Introduction to the Six Essentials of Photography
Light • Subject • Optics • Aperture • Time • Recording Medium

PRINTABLE INFOGRAPHICS

We have put together everything you might need to refer to while out shooting, so you can print a copy of the key concepts to take along with you. Good luck with your continuing photography education.

APERTURE

SIZE



DEPTH OF FIELD

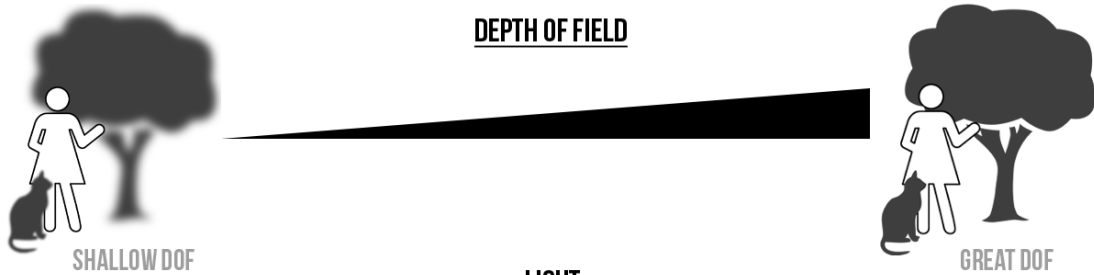

LIGHT



WHITE BALANCE



AUTO WHITE BALANCE

Camera selects the white balance automatically based on the lighting



CUSTOM WHITE BALANCE

Photographer manually sets white balance according to Kelvin scale



TUNGSTEN

Camera adds cool tones



FLUORESCENT

Camera adds magenta to cancel green light



DAYLIGHT

Colour balance remains neutral



FLASH

Colour balance remains neutral



CLOUDY

Camera adds warm tones



SHADE

Camera adds slightly warmer tones

KELVIN SCALE

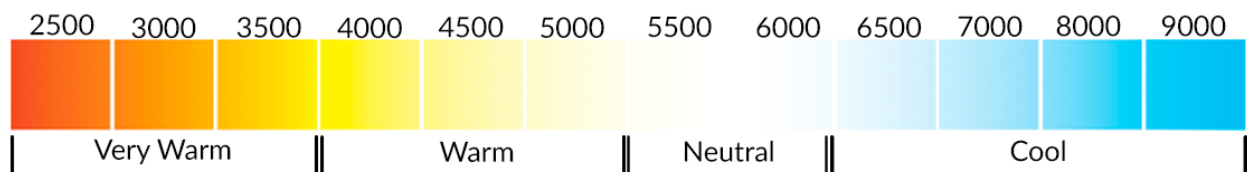

EXPOSURE CHANGES

APERTURE

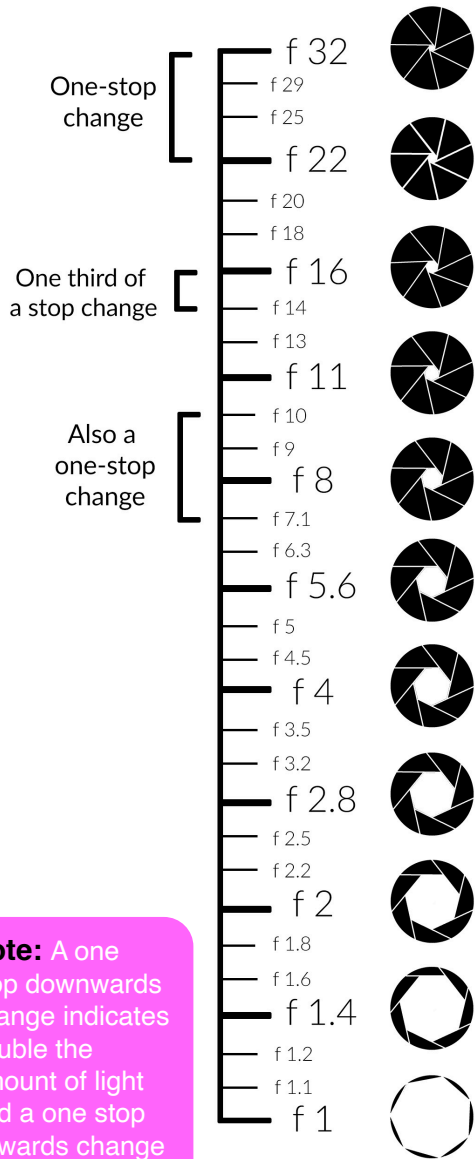

LIGHT



SHUTTER SPEED

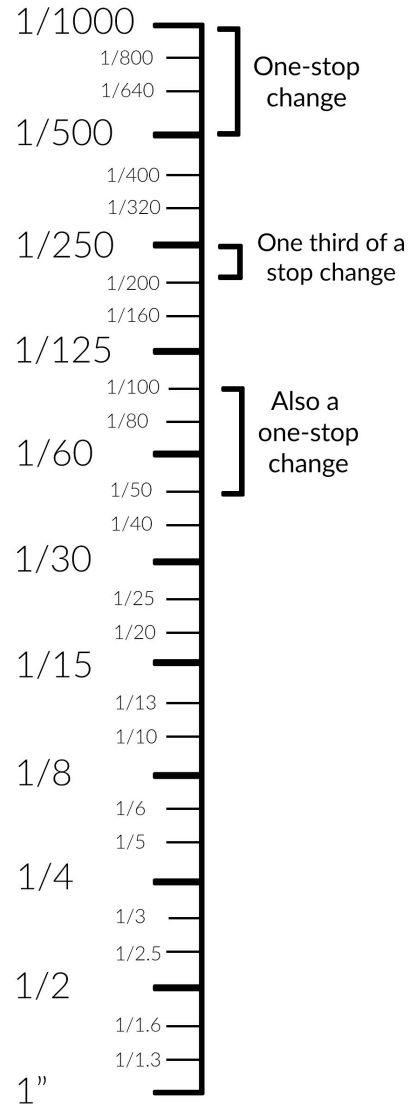

Note: A one stop downwards change indicates double the amount of light and a one stop upwards change indicates half the amount of light.



SHUTTER SPEED

TIME



1" 1/2 sec 1/4 sec 1/8 sec 1/15 sec 1/30 sec 1/60 sec 1/125 sec 1/250 sec 1/500 sec 1/1000 sec

SLOW SHUTTER SPEED

FAST SHUTTER SPEED

LIGHT



MORE LIGHT

LESS LIGHT

SHUTTER SPEED



1 1/2 1/4 1/8 1/15 1/30 1/60 1/125 1/250 1/500 1/1000

SLOW SHUTTER SPEED

FAST SHUTTER SPEED



POLITEKNIK BALIK PULAU
PINANG NIRAI, MUKIM 6
11000 BALIK PULAU
PULAU PINANG

04-8689000

polibalikpulau@pbu.edu.my